



RE-008RP

RE-064RP

RE-128RP

Fire Alarm Repeater Panel

Installation, Commissioning & Operating

user Manual

Fire Alarm System Limitations

An automatic fire alarm system—typically made up of smoke detectors, heat detectors, manual Call Points, audible warning devices, and a fire alarm control with remote notification capability—can provide early warning of a developing fire. Such a system, however, does not assure protection against property damage or loss of life resulting from a fire. The Manufacturer recommends that smoke and/or heat detectors be located throughout a protected premise following the recommendations of the current edition of the National Fire Protection Association Standard 72 (NFPA 72), manufacturer's recommendations, State and local codes, and the recommendations contained in the Guide for Proper Use of System Smoke Detectors, which is made available at no charge to all installing dealers. A study by the Federal Emergency Management Agency (an agency of the United States government) indicated that smoke detectors may not go off in as many as 35% of all fires. While fire alarm systems are designed to provide early warning against fire, they do not guarantee warning or protection against fire. A fire alarm system may not provide timely or adequate warning, or simply may not function, for a variety of reasons:

Smoke detectors may not sense fire where smoke cannot reach the detectors such as in chimneys, in or behind walls, on roofs, or on the other side of closed doors. Smoke detectors also may not sense a fire on another level or floor of a building. A second-floor detector, for example, may not sense a first-floor or basement fire.

Particles of combustion or "smoke" from a developing fire may not reach the sensing chambers of smoke detectors because:

- Barriers such as closed or partially closed doors, walls, or chimneys may inhibit particle or smoke flow.

- Smoke particles may become "cold," stratify, and not reach the ceiling or upper walls where detectors are located.
- Smoke particles may be blown away from detectors by air outlets.
- Smoke particles may be drawn into air returns before reaching the detector.

The amount of "smoke" present may be insufficient to alarm smoke detectors. Smoke detectors are designed to alarm at various levels of smoke density. If such density levels are not created by a developing fire at the location of detectors, the detectors will not go into alarm.

Smoke detectors, even when working properly, have sensing limitations. Detectors that have photoelectronic sensing chambers tend to detect smoldering fires better than flaming fires, which have little visible smoke. Detectors that have ionizing-type sensing chambers tend to detect fast-flaming fires better than smoldering fires. Because fires develop in different ways and are often unpredictable in their growth, neither type of detector is necessarily best and a given type of detector may not provide adequate warning of a fire.

Smoke detectors cannot be expected to provide adequate warning of fires caused by arson, children playing with matches (especially in bedrooms), smoking in bed, and violent explosions (caused by escaping gas, improper storage of flammable materials, etc.).

While a fire alarm system may lower insurance rates, it is not a substitute for fire insurance!

Heat detectors do not sense particles of combustion and alarm only when heat on their sensors increases at a predetermined rate or reaches a predetermined level. Rate-of-rise heat detectors may be subject to reduced sensitivity over time. For this reason, the rate-of-

rise feature of each detector should be tested at least once per year by a qualified fire protection specialist. *Heat detectors are designed to protect property, not life.*

IMPORTANT! Smoke detectors must be installed in the same room as the control panel and in rooms used by the system for the connection of alarm transmission wiring, communications, signaling, and/or power. If detectors are not so located, a developing fire may damage the alarm system, crippling its ability to report a fire.

Audible warning devices such as bells may not alert people if these devices are located on the other side of closed or partly open doors or are located on another floor of a building. Any warning device may fail to alert people with a disability or those who have recently consumed drugs, alcohol or medication.

Please note that:

- Strobes can, under certain circumstances, cause seizures in people with conditions such as epilepsy.
- Studies have shown that certain people, even when they hear a fire alarm signal, do not respond or comprehend the meaning of the signal. It is the property owner's responsibility to conduct fire drills and other training exercise to make people aware of fire alarm signals and instruct them on the proper reaction to alarm signals.
- In rare instances, the sounding of a warning device can cause temporary or permanent hearing loss.

A fire alarm system will not operate without any electrical power. If AC power fails, the system will operate from standby batteries only for a specified time and only if the batteries have been properly maintained and replaced regularly.

Equipment used in the system may not be technically compatible with the control. It is essential to use only equipment listed for service with your control panel.

Telephone lines needed to transmit alarm signals from a premise to a central monitoring station may be out of service or temporarily disabled. For added protection against telephone line failure, backup radio transmission systems are recommended.

The most common cause of fire alarm malfunction is inadequate maintenance. To keep the entire fire alarm system in excellent working order, ongoing maintenance is required per the manufacturer's recommendations, and UL and NFPA standards. At a minimum, the requirements of NFPA 72 shall be followed. Environments with large amounts of dust, dirt or high air velocity require more frequent maintenance. A maintenance agreement should be arranged through the local manufacturer's representative. Maintenance should be scheduled monthly or as required by National and/or local fire codes and should be performed by authorized professional fire alarm installers only. Adequate written records of all inspections should be kept.

NOTES:

Table of Contents

CHAPTER 1: Introduction	9
1.1: System Design & Planning.....	9
1.2: General	9
1.3: Fire Alarm Procedure	10
CHAPTER 2: Product Description	11
2.1: Product Features	11
2.2: Specifications	12
2.3: Controls and Indicators	14
2.3.1: LED Indication.....	14
2.3.2: Controls.....	15
2.4: Mechanical Construction.....	16
CHAPTER 3: Installation	18
3.1: Installation Precaution.....	18
3.2: Mounting Details	21
3.3: Input Circuits.....	22
3.4: Output Circuits	22
3.4.1: Sounder Circuits.....	22
3.4.2: Fire Relay	23
CHAPTER 4: Programming Instructions	24
4.1: Menu Key Flow Diagram.....	23
4.2: Programming.....	26
4.2.1: Suppressed Events.....	26
4.2.1.1: Supervisory.....	26
4.2.1.2:Fault.....	27
4.2.2:Program.....	28
4.2.2.1: Repeater Setting.....	28
4.2.2.1.1: Change Password.....	29
4.2.2.1.1.1: User Password.....	29
4.2.2.1.1.2: Admin Password.....	30

4.2.2.1.3: Restore default.....	30
4.2.2.2: Network Configuration.....	30
4.2.2.2.1: Zone Config.....	30
4.2.2.2.2: Location program.....	31
4.2.2.2.3: Panel select mode.....	32
4.2.2.2.4: View model.....	32
4.3 About	33
4.4 Reset.....	33
CHAPTER 5: Operating Instructions.....	36
5.1: Switch Functions	34
5.2: Status LEDs.....	35
5.3: Operation.....	36
5.3.1: Normal Monitoring Mode.....	36
5.3.2: Fire Alarm Condition.....	46
5.3.3: Supervisory.....	38
5.3.4: Fault	39
5.3.5: Zone Isolation.....	40
CHAPTER 6: Servicing.....	41
CHAPTER 7: Battery Calculation.....	42
CHAPTER 8: Trouble Shooting.....	43
CHAPTER 9: Abbreviation.....	45

Chapter 1: Introduction

This manual is intended as a complete guide to the RE-RP Series common conventional repeater Panel. User operating Instructions are provided in the first part of this manual. This is followed with sections describing installation and commissioning procedures and full technical details.

1.1 System Design and Planning

It is assumed that the system, of which this repeater panel is a part, has been designed by a competent fire alarm system designer in accordance with the requirements of IS 2189: 1988 and any other local codes of practice that are applicable. The design drawings should clearly show the positions of the field devices and the control equipment.

1.2 General

The panel is self-contained with integral power supply and space provision for two sealed lead-acid standby batteries and comply with the requirements of IS 2189: 1988. The panel functions are microprocessor controlled. Provision is made for a repeater function of panel status output.

Installation

The panel is easy to install and operate. Control functions Programming functions are enabled by using password. The panel fascias are retained by tamper-proof screws.

1.3 Fire Alarm Procedures

In accordance with IS 2189: 1988, written procedures should be laid down for dealing with alarms of fire, fault warnings, and the isolation of any part of the system. The responsible person should ensure that users of the system are instructed in its proper use and are familiar with the procedures.

On hearing the fire alarm:

CARRY OUT THE PRESCRIBED PROCEDURE Subsequent actions will depend on the circumstances, and may include silencing the audible alarms and resetting the system, as described later.

To Evacuate the premises:

Press the Evacuate key and enter the password to OPERATE SOUNDERS.

Fault Indication:

If the control panel indicates a Fault condition, make a note of all illuminated indicators, refer to the chart on page 47, and call the engineer.

Chapter 2: Product Description

RE-RP Series is a conventional Fire alarm repeater Panel. RE-RP Series are a range of repeater panels compatible with fire alarm panel. It repeats function like fire, fault, supervisory etc that occur on the main panel. The Repeater panel is connected to the FACP via the RS485 using CAT5E (2C*1.5Sqmm shielded twisted pair) communication cable.

2.1 Product Features

- Operates on 120 to 220V AC, 60 / 50 Hz.
- 20 X 4 Characters LCD display.
- Repeats all the indication / Information of main panel.
- RS 485 Communication for Standalone / Network Repeater.
- System ON, AC ON, Battery ON, Charger ON indications.
- Alphanumeric keypads.
- Sounder (Evacuate) test facility.
- Lamp test facility.
- RE-RP Series is Compatible with RE-2558& RE-2554, .

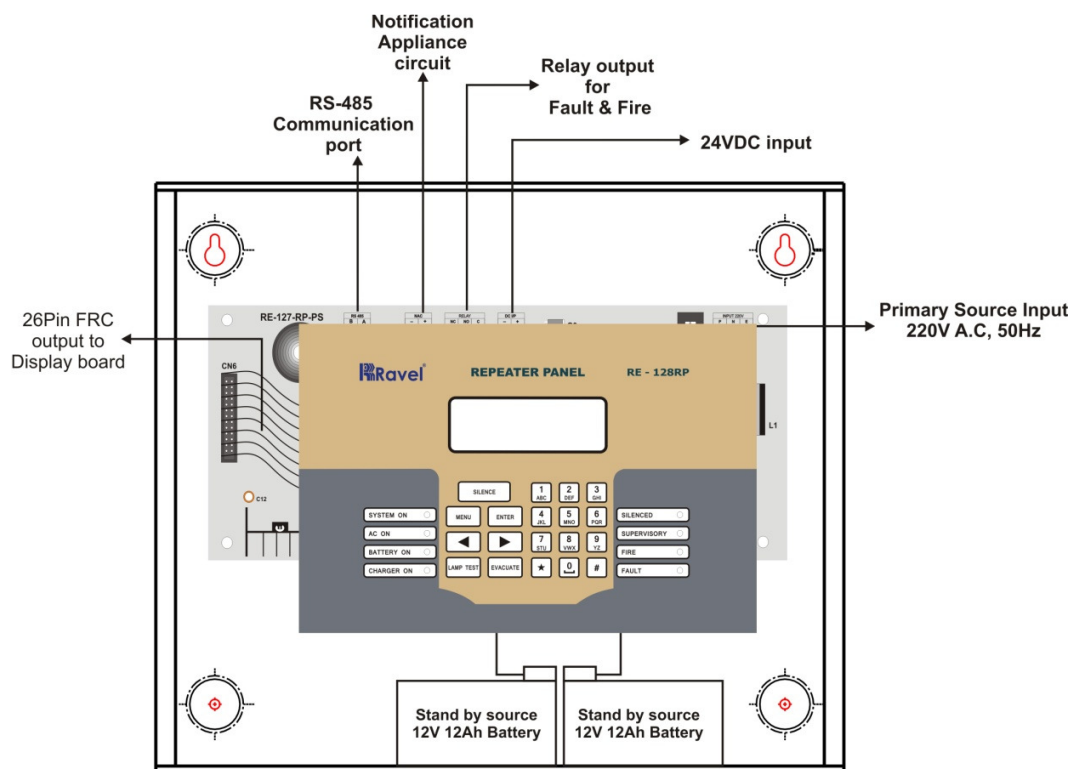

Figure -1

2.2 Specification

AC Power:

120 - 220VAC 60/50 Hz

Battery (Lead Acid only)

Charging Current: Constant Voltage – 27.6v @ 0.8A (Max.).

Charging Capacity: 7 Amp Hour Battery.

System Quiescent Current: 50mA

Notification Appliance Circuits (Sounder/Hooter Circuit)

Class – B wiring

Operating Nominal Voltage: 24 VDC

Sounder (NACs) output: 0.5A

End-Of-Line Resistor: 4.7K, 1/4watt

RS485 Communication Port

Max. Distance: 1.2 Km Max.[CAT5E or Equivalent]

Remote Outputs

Fire Contact (C,NO,NC) : 220VAC @ 0.5A / 30VDC @ 1A.

2.3 Control and Indicators.

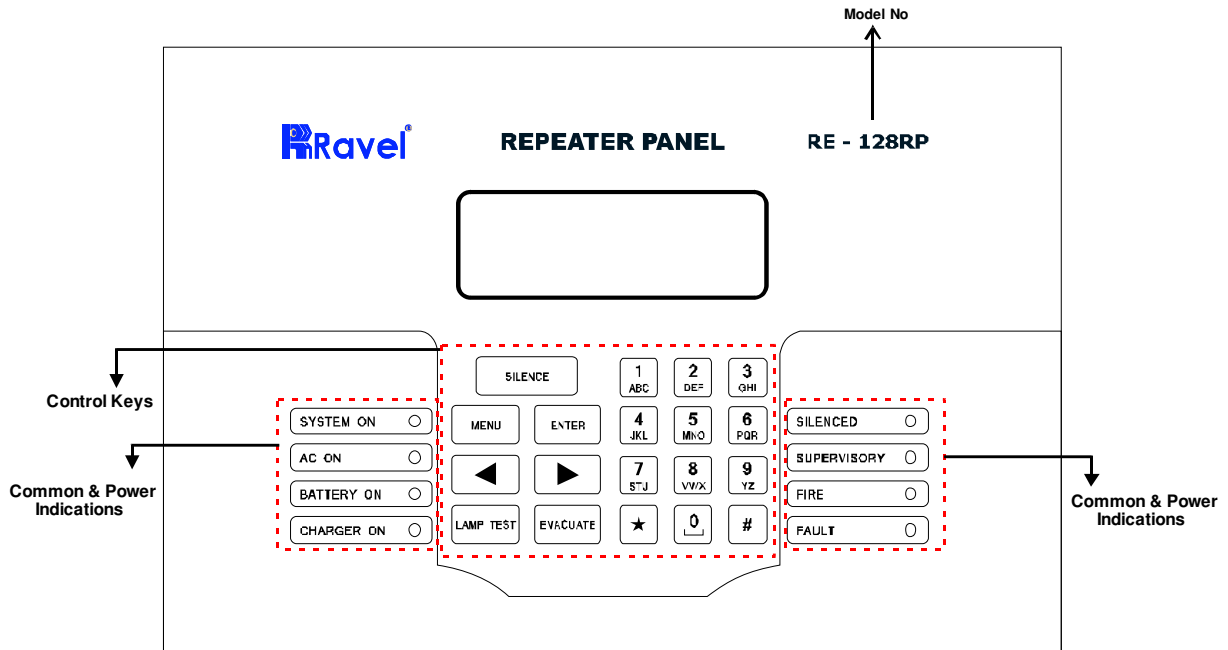

Figure -2

2.3.1 LED Indication

- System On – Green
- A.C On – Green
- Battery On – Green
- Charger On – Green
- Silenced – Yellow
- Supervisory–yellow
- Fire – Red
- Fault –yellow

Local Buzzer

A piezo buzzer provides separate and distinct sounds for alarm, trouble and supervisory conditions:

- ✓ Alarm – steady
- ✓ Fault – pulse 0.5sec ON and 3 sec OFF
- ✓ Supervisory – 0.25sec ON and 0.25sec OFF

2.3.2 Controls:

SILENCE: During fire/fault condition, silence is used to silence the external Sounders connected in repeater panel (NAC) and the internal buzzer tone is changed from continuous tone to toggle tone in **fire** condition and also used to silence the internal buzzer toggle tone in fault condition.

NOTE 1: silence key is also used to silence main panel connected in network.

MENU KEY: To enter into the Main Menu in the LCD.

ENTER KEY: To accept the programmed or edited menu, mode or value in the LCD.

Lamp Test: All the LED's of the panel can be checked using Lamp Test key. When the lamp test key is pressed, all the LED will glow continuously for 4 seconds with continuous buzzer tone.

Evacuate Test: The External Hooters or Sounder (NAC) connected in RE-RPseries can be activated without the actual fires by using evacuate Key. The LCD display shows that Evacuate ON as shown below. The evacuate can bring back to normal condition by bring back the key pad enable key to disable position or external sounder are silenced by using the silence key.

ALPHANUMERIC KEYS:

- ✓ These keys are used for entering the names etc. and numbers.
- ✓ '*' Key is used to go back to the previous screen in programming mode.
- ✓ '#' key is used to change the status of modes.

2.4 Mechanical Construction

The enclosure of the Panel is constructed with 18 gauge (1.22mm) CRCA sheet and has powder-coated finish. Ø19mm of knockouts are given for cable entry at the top of the cabinet. The lockable hinged door is provided to access the inside of the cabinet. The panel also has sufficient space to accommodate 2 Nos. of 12v, 7Ah batteries.

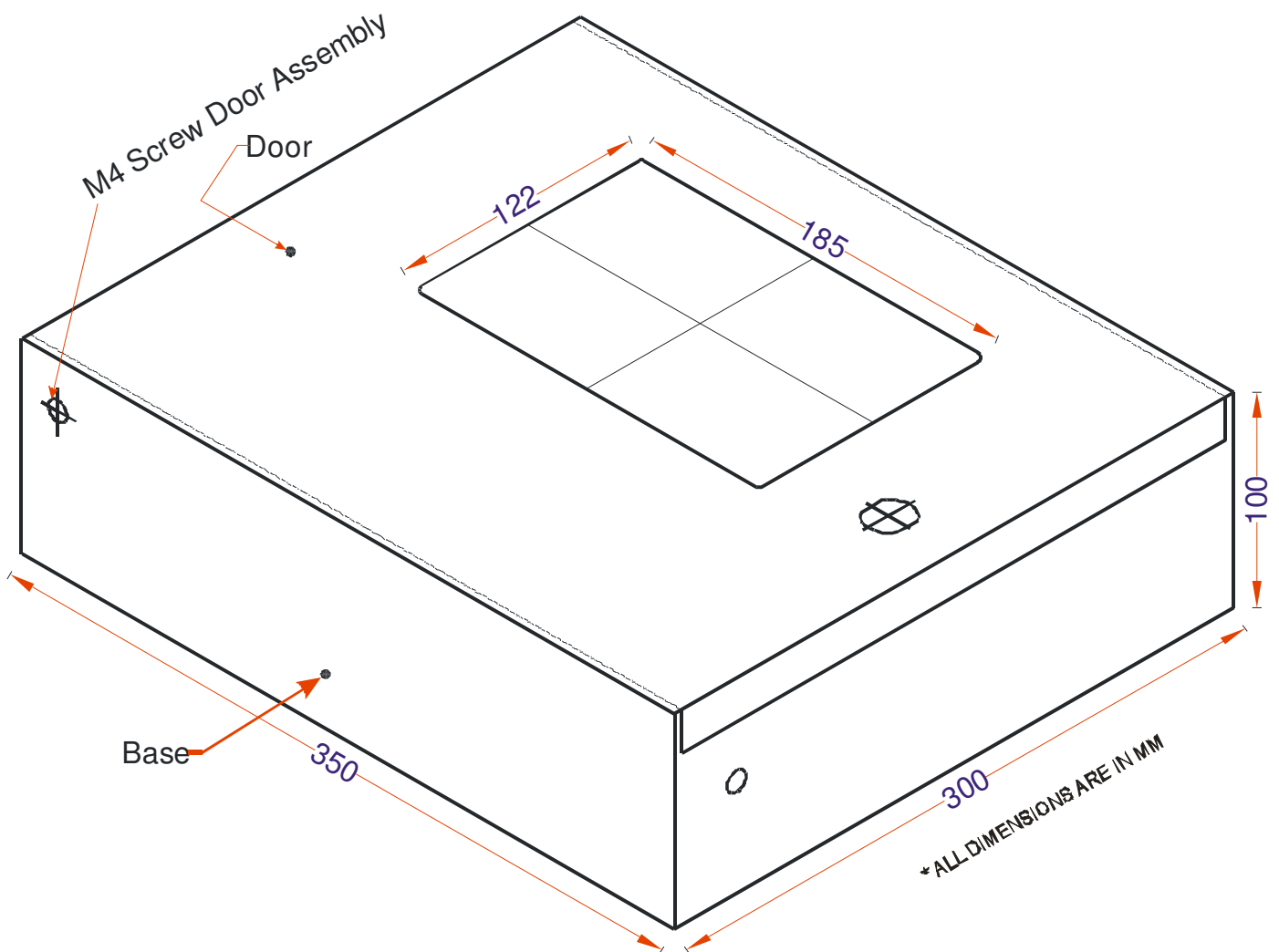

Figure -3

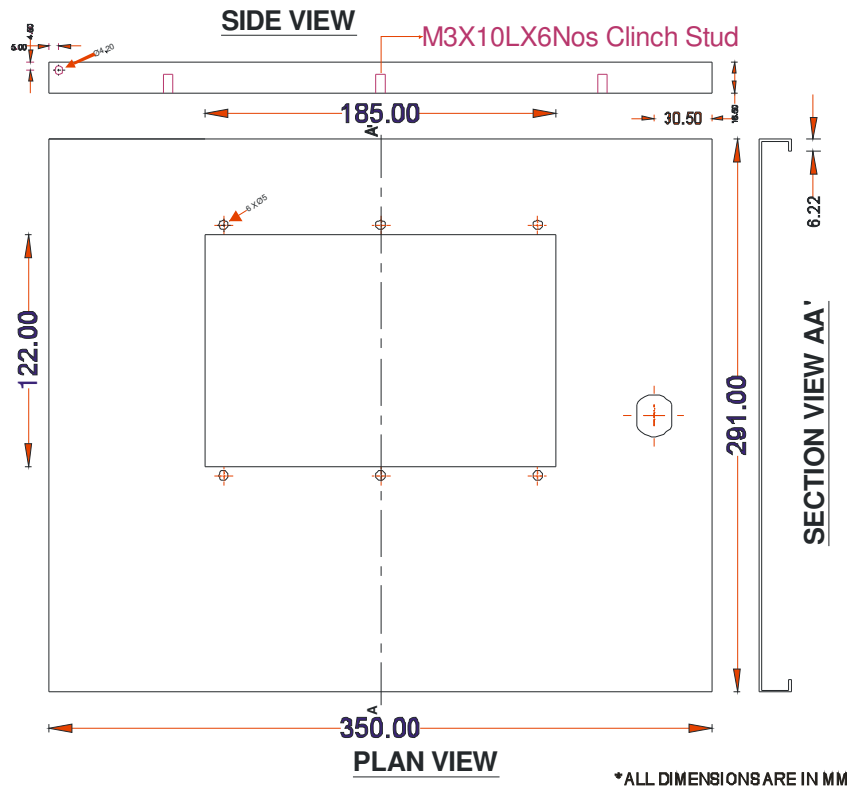
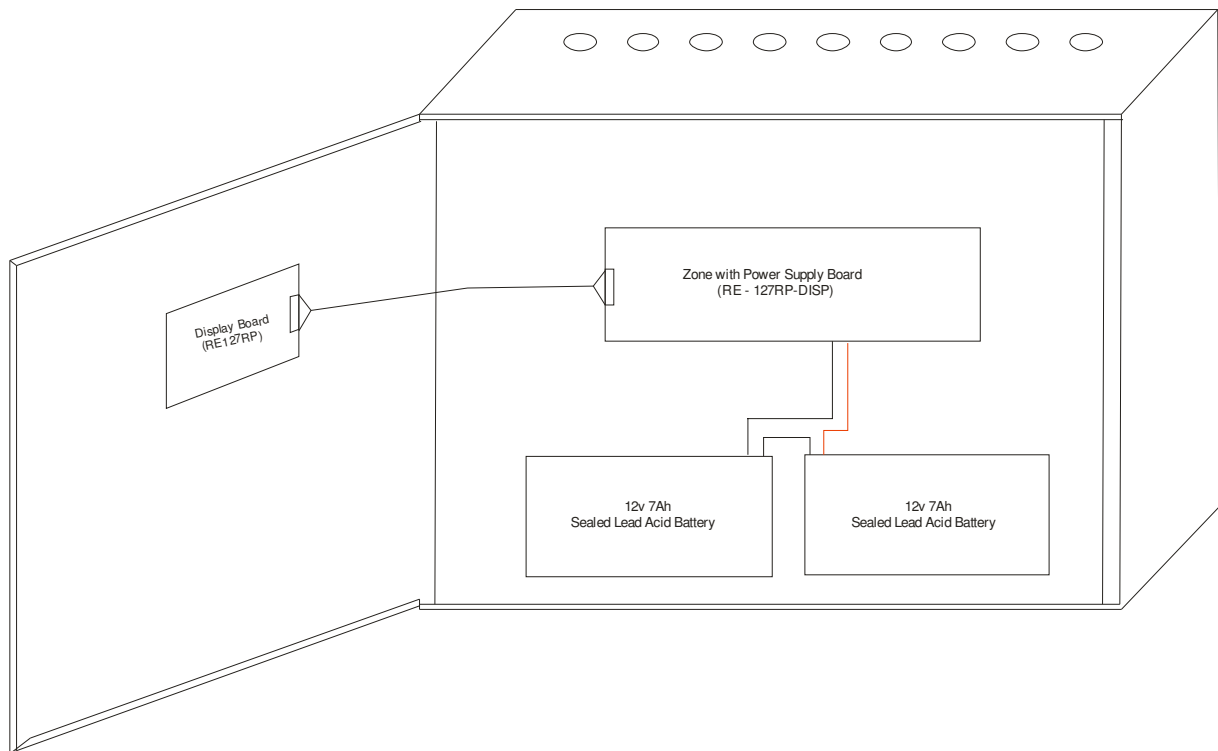

Figure -4



Chapter 3: Installation

3.1 Installation Precaution



Installation Precautions

WARNING - Several different sources of power can be connected to the fire alarm control panel. Disconnect all sources of power before servicing. Control unit and associated equipment may be damaged by removing and/or inserting cards, modules, or interconnecting cables while the unit is energized. Do not attempt to install, service, or operate this unit until this manual is read and understood.

CAUTION - System Reacceptance Test after Software Changes. To ensure proper system operation, this product must be tested in accordance with NFPA 72 after any programming operation or change in site-specific software. Reacceptance testing is required after any change, addition or deletion of system components, or after any modification, repair or adjustment to system hardware or wiring. All components, circuits, system operations, or software functions known to be affected by a change must be 100% tested. In addition, to ensure that other operations are not inadvertently affected, at least 10% of initiating devices that are not directly affected by the change, up to a maximum of 50 devices, must also be tested and proper system operation verified.

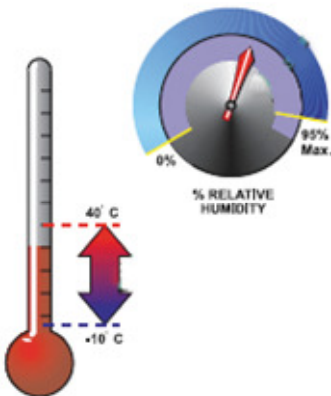
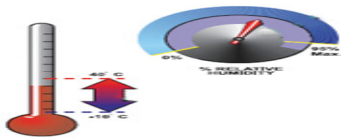

This system meets NFPA requirements for indoor dry operation at 0-49° C/32-77° F and at a relative humidity of 93 ±2% RH (non-condensing) at 25 ±2° C/77 ±3° F. However, the useful life of the system's standby batteries and the electronic components

may be adversely affected by extreme temperature ranges and humidity. Therefore, it is recommended that this system and all peripherals be installed in an environment with a nominal room temperature of 15-25° C/60-77° F.

Verify that wire sizes/type are adequate for communication. Most devices cannot tolerate more than a 10% I.R. drop from the specified device voltage.

Adherence to the following will aid in problem-free installation with long-term reliability:

Like all solid-state electronic devices, this system may operate erratically or can be damaged when subjected to lightning-induced transients. Although no system is completely immune from lightning transients and interferences, proper grounding will reduce susceptibility. *Overhead or outside aerial wiring is not recommended, due to an increased susceptibility to nearby lightning strikes.* Consult with the Technical Services Department if any problems are anticipated or encountered.

Disconnect AC power and batteries prior to removing or inserting circuit boards. Failure to do so can damage circuits.

Remove all electronic assemblies prior to any drilling, filing, reaming, or punching of the enclosure. When possible, make all cable entries from the sides or rear. Before making modifications, verify that they will not interfere with battery, transformer, and printed circuit board location.

Do not tighten screw terminals more than 1.0168 N-m.

Over-tightening may damage threads, resulting in reduced terminal contact pressure and difficulty with screw terminal removal.

Though designed to last many years, system components can fail at any time. This system contains static-sensitive components. Always ground yourself with a proper wrist strap before handling any circuits so that static charges are removed from the body. Use static-suppressive packaging to protect electronic assemblies removed from the unit.

Follow the instructions in the installation, operating, and programming manuals. These instructions must be followed to avoid damage to the control panel and associated equipment. FACP operation and reliability depend upon proper installation by authorized personnel.

3.2. Mounting Detail

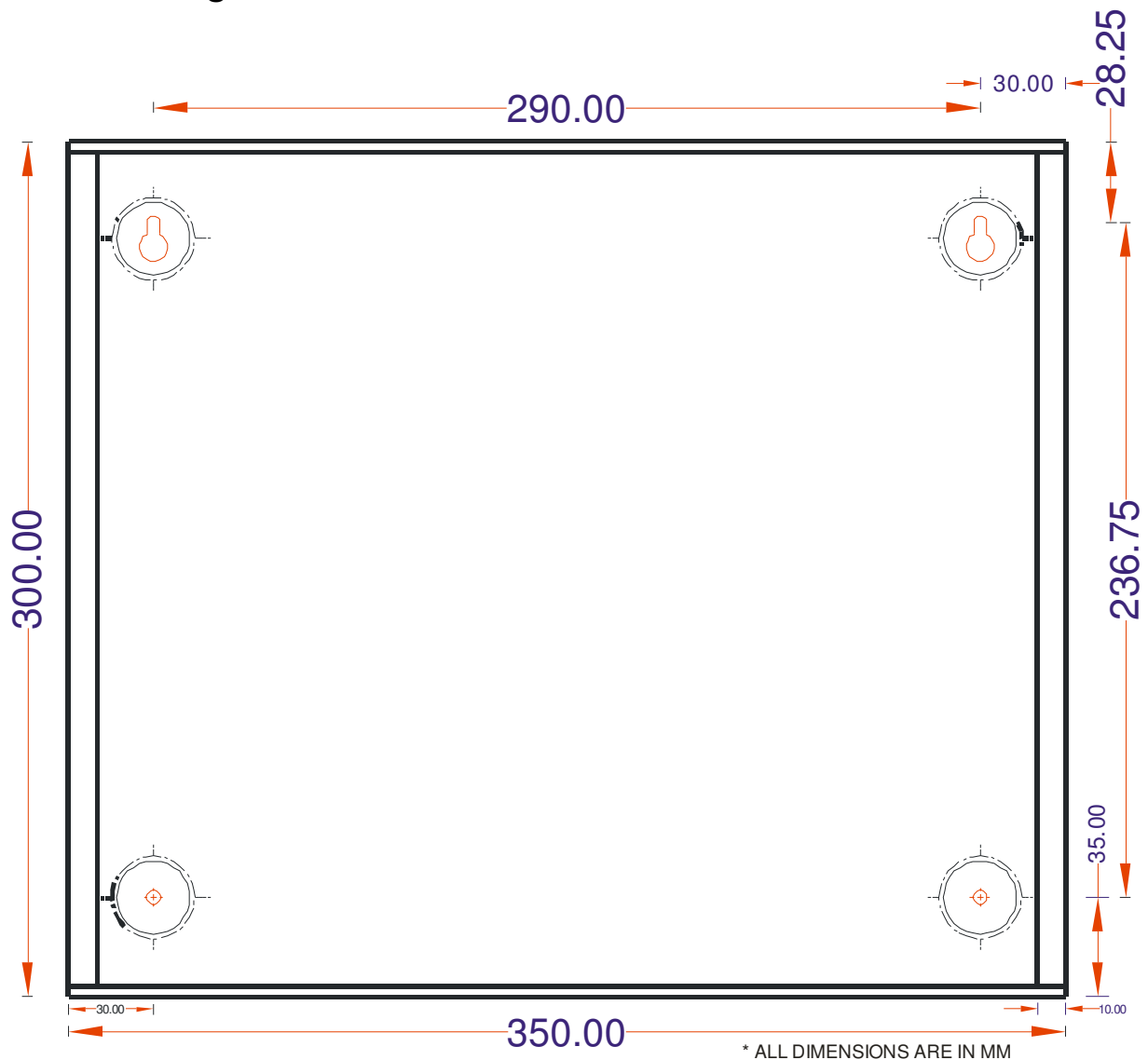

Figure -4

Place the panel in its mounting position and fix the panel to the wall using the slots of the four screws. Ensure the enclosure and the inner parts of the panel are given sufficient protection during installation. All external cables are to be entered via the $\varnothing 19\text{mm}$ preformed knockouts located at the top of the panel.

When the installation of all the cables has been completed, clean the interior of the enclosure ensuring all masonry debris and drilling swords are removed

3.3 Input Circuits

The communication between Repeater panel and Main panel is by means of RS485. For every 1.2Km Cable length or 32 devices the RS-485 Booster should be provided. Communication cable should be CAT5E or equivalent.

Connection Topology diagram

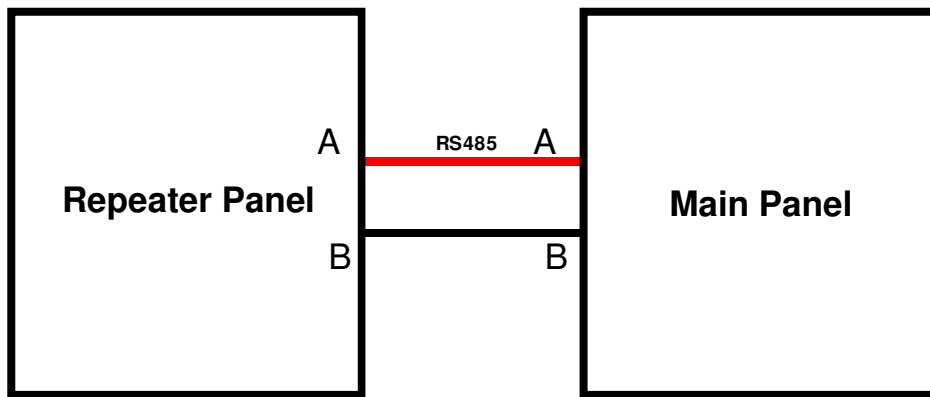

Repeater Panel Model

Compatible Main Panel

RE-008RP /RE-064RP /RE-128RP → RE-2554& RE-2558.

Output Circuits

3.4.1: Sounder Circuits

The RE – RP Series provides One Class B Notification Appliance Circuits. This circuit is capable of a maximum of 0.5 amps of current.

Class B Notification Appliance Circuit (supervised). 4.7K ohm, ½ watt.

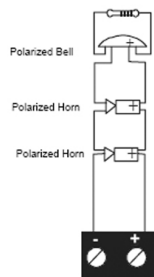

Note: Notification Appliance Circuit polarity shown in alarm state.

E. O. L. RESISTOR 4.7K OHMS FOR UNUSED ZONE LOOPS

Figure -5

3.4.2: Fire Relay

The Fire Alarm control panel provides one Form-C relays rated 2.0 amps @ 30 VDC and 2.0 amps @ 30 VAC for fire and one for fault (Optional).

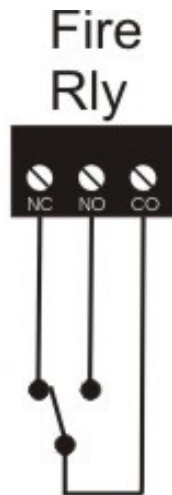

Relay contacts shown with power applied to the panel no active Fire

Figure -6

Chapter 4: Programming Instructions

4.1 Menu Key flow diagram

MENU KEY - FLOW DIAGRAM

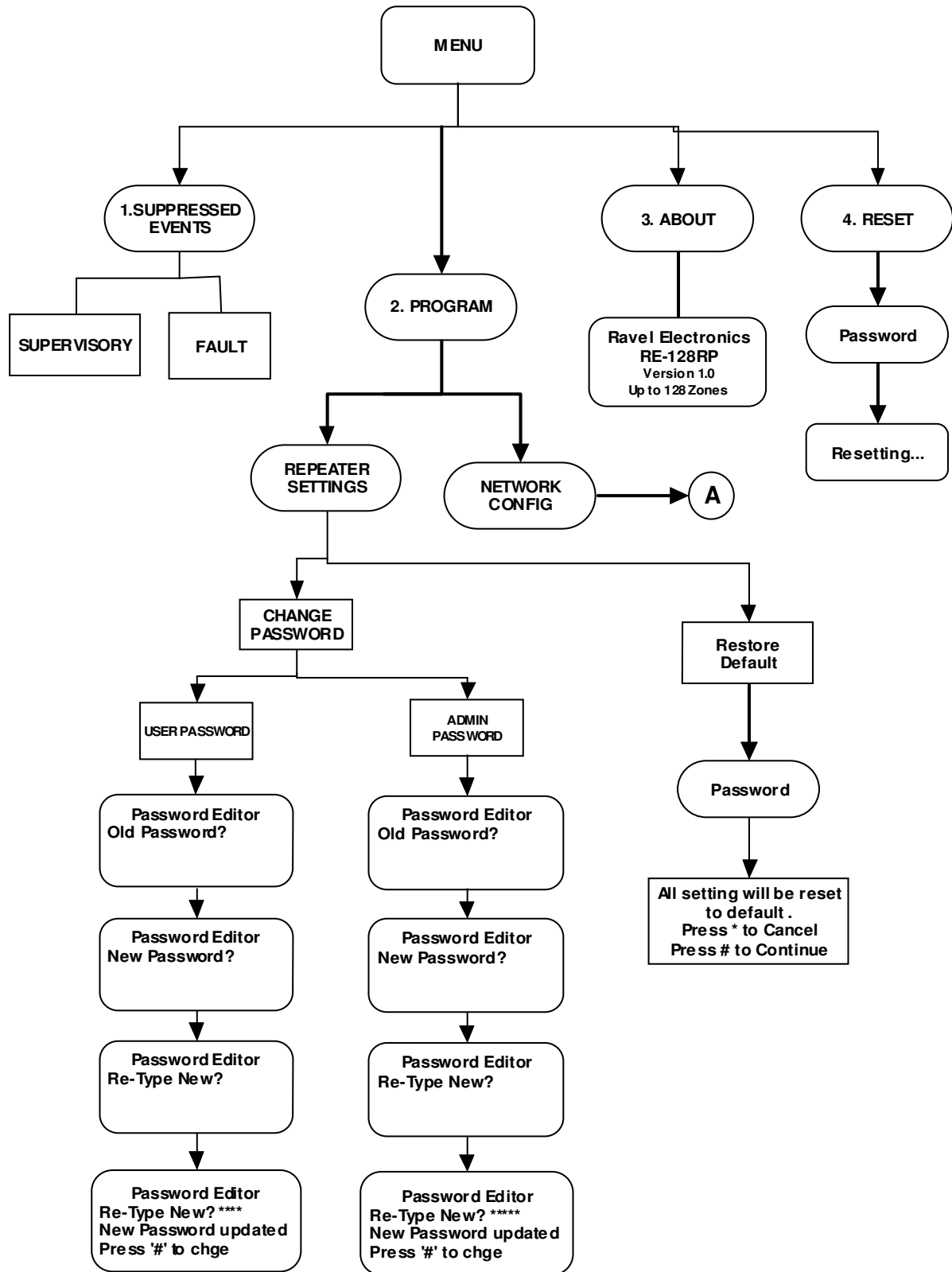

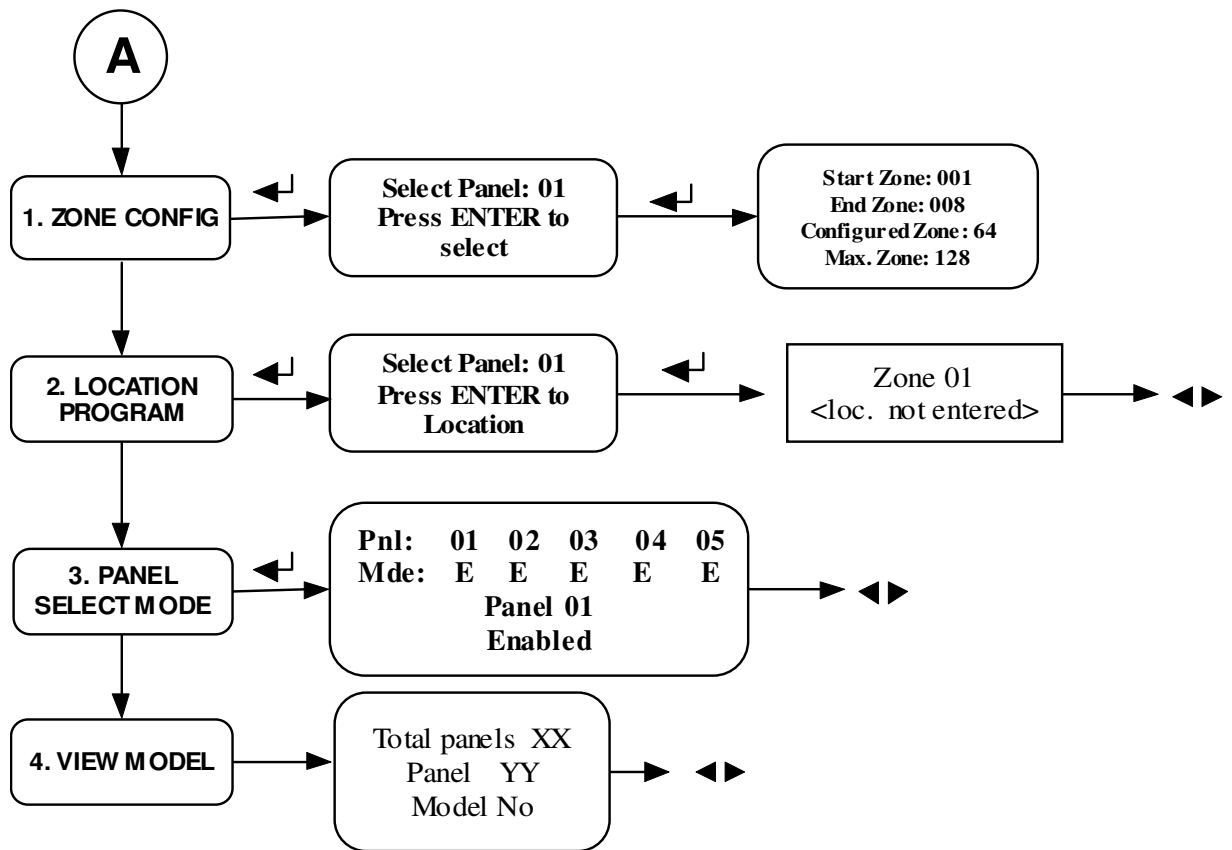

NOTE:

- 1) ◀▶ Pressing the Left and Right arrow keys should allow you to scroll left and right the page you are viewing.

4.2 Programming:

MENU KEY:

The **MENU** key is used to enter into the programming mode for changing the Repeater and network config. The various steps involved in this menu are shown as flow chart 1. After entering in to the menu, the screen will be as below.



4.2.1 Suppressed Events

By selecting the number 1 from menu screen, system enters into the suppressed events mode. In this mode the suppressed events other than fire events can be viewed sequentially using the right / left arrow keys.



Note: Through suppressed events feature you can view the fault occurred currently during alarm condition.

4.2.1.1 Supervisory

When the main panel detects supervisory signal via the any normally open contact devices, the repeater panel will replicate the same in the repeater panel.

The common supervisory LED will glow. The LCD screen will be displayed as shown below.

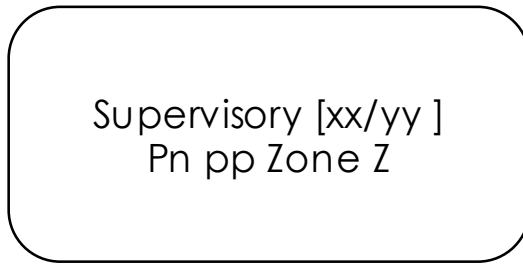

If there is more than one supervisory events the screen shown as above.

x – index no. of supervisory event; **y** – Total no. of Supervisory events;

Zone Z – Denotes the zone number who's programmed site specific location shown in the repeater display screen.

To change the other indexed supervisory event zones which are suppressed use right / left arrow keys.

Restoral: When the supervisory Condition is cleared in the main panel, the repeater panel will perform the following,

- Turn off the Supervisory LED
The LCD screen will be as below. This LCD screen will replicate in the Repeater Panel.



4.2.1.2 Fault

The suppressed fault events are viewed by selecting the number 2 from the suppressed events screen. The display screen as shown below.

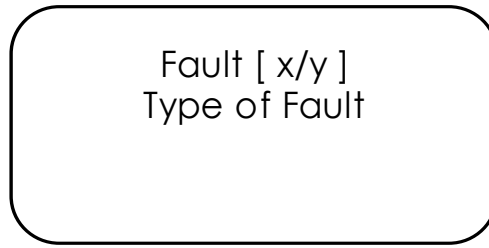

x – nth no. of events; **y** – Total no. of events.

4.2.2 Program

NOTE: Access to programming is possible only by Admin password (Default Password – 56789).

By selecting the number 2 from the menu screen, system enters into the program mode. The Repeater settings and network configurations are done in this program mode. After entering the program mode, screen will be as below.



4.2.2.1. Repeater Settings:

By selecting the number 1 from above the program screen, system enters into Repeater setting Mode. It is further classified into Change password, & restore default. By selecting the number 1 from the setting below screen, the change password is used to reset the new password of Repeater Panel.



By choosing the number 1 from the above figure. It is classified in to User password and Admin Password. The LCD screen is shown below.

- 1. User Password
- 2. Admin Password

4.2.2.1.1 Change Password

4.2.2.1.1.1 User Password:

By selecting the number 1 from the change Password screen, system enters into the user Password change mode. The display screen of this mode showed as below. The Default Password is "1234". The Password should be four digit.

Old Password?



Old Password? XXXX
New Password?



Old Password? XXXX
Confirm New?



4.2.2.1.2Admin Password:

By selecting the number 2 from the Change password screen, system enters into the Admin Password change mode. The Default Password is "**56789**". The Password should be five digit. It is similar to the user password change method.

4.2.2.3.Restore Default:

By pressing the Restore Default Key, All settings will be reseted.

4.2.2.2.Network configuration:

By pressing the number 2 under the Program screen, the panel setting are zone config, location program, panel select mode and view model configuration setting are done. They are as follows

4.2.2.2.1 ZoneConfig:

By selecting the number 1 from the program screen---Panel setting, system enters into the zone config mode. In this mode the number of panel can be selected and start zone and End zone can be set. After entering the set zone mode, screen will be as below.



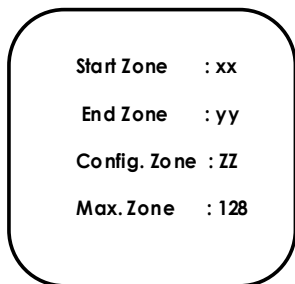

AA = Number of panel to be selected Max 16 Panel.

XX = Start zone number

YY = Ending Zone number

ZZ = 08 or 64 or 128 Zones

The start zone & end zone is selected by using the ENTER key. Then press the LEFT/RIGHT key to change the no of zones. This process can be continued in case of other Panels to be changed.

4.2.2.2.2 Location Program:

By selecting the number 1 in the keypad from setting menu, it enters into the location program Mode screen. When entering into this it will ask the zone number. After entering the zone number press ENTER key, cursors goes to next line. Then enter the location using the number / letter key pad, press ENTER key after entering location.

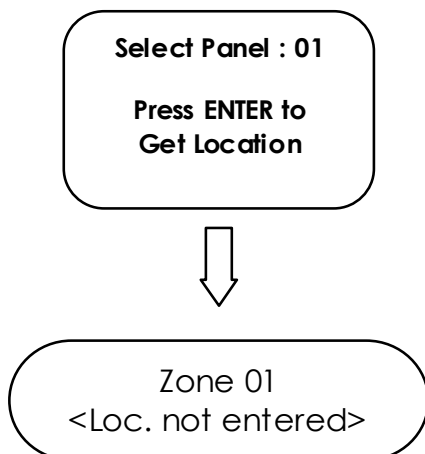

The display showed as above. It will stay in location entering mode to continue location entering, so to go back press '*' key. Use left/Right Key to view no of Zones.

4.2.2.2.3 Panel select Mode: In this mode, the panel is selected by entering the number as no of panel connected. By entering the number 3 from networking configuration mode. The display screen will be shown below.

Pnl :	01	02	03	04	05
Mde:	E	E	E	E	E

Pressing the **LEFT/RIGHT** keys should allow you to no of panels andby '#'Key the mode can change Enable / Disable the zone.

Note:Pnl:- Panel Address ; Mde :- Mode

4.2.2.2.4. View Model:

It shows the details of the panel by pressing number 4 from the network config. The LCD will show as below.

Total panels XX
Panel YY
ModelNo

XX – is the total number of panels connected.

YY – Panel Address

Model no - RE-2558/ RE-2554.Pressing the **LEFT/RIGHT** keys should allow you to view the model no scroll left and right the page you are viewing.

4.3 About:

It shows the details of the panel by pressing number 3 from the main menu. The LCD will show as below.

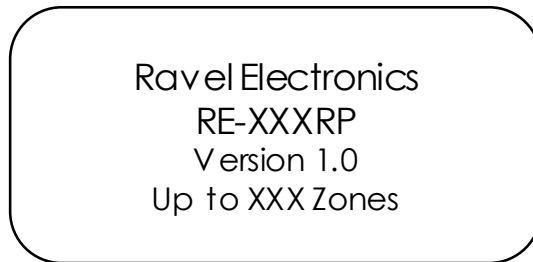

Where XXX – 8 / 64 / 128 Zones

4.4.Reset: By pressing the number 4 from the Menu key Repeater panel resets both the main panel and repeater panel. The screen will be

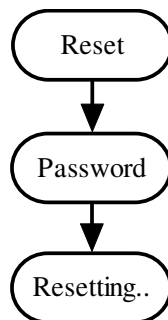

Chapter 5: Operating Instruction

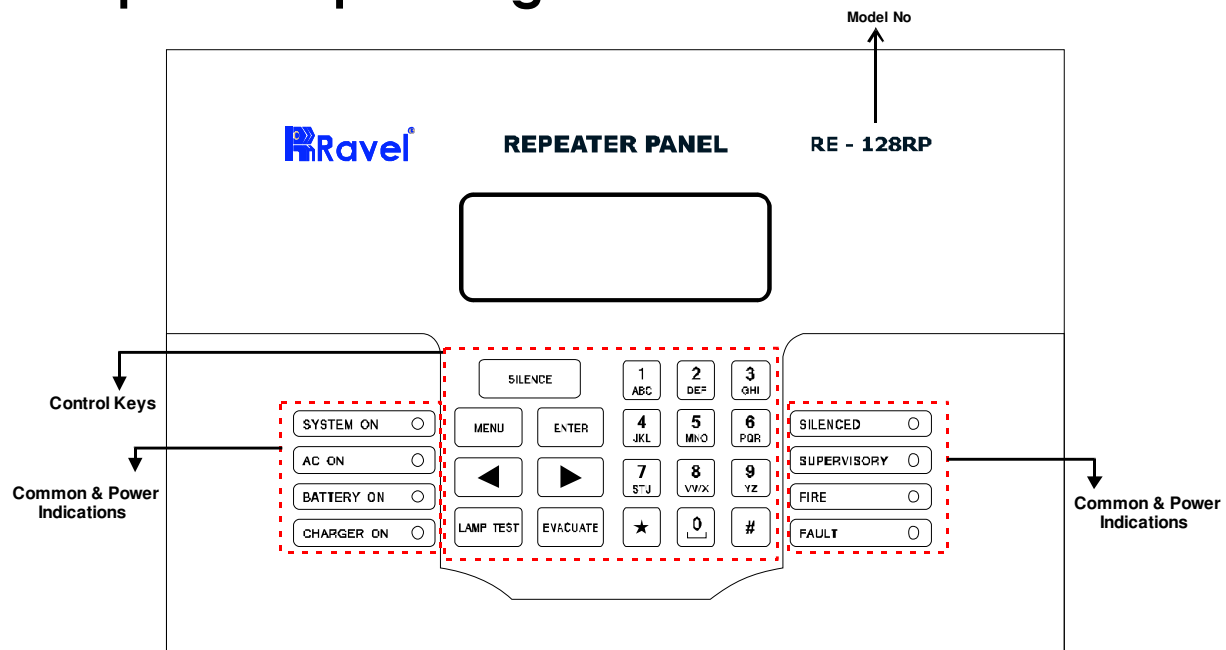

Figure -7

5.1 Switch Functions

SILENCE Key: This key is used in Fire / Fault Condition. To acknowledge the external sounder / internal buzzer press this key. And the internal buzzer tone is changed from continues tone to toggle tone for fire condition.

MENU KEY: To enter into the Main Menu in the LCD.

ENTER KEY: To accept the programmed or edited menu, mode or value in the LCD.

EVACUATE Key: This key is used to energize the external sounders without actual fire.

LAMP TEST Key: This key is used to check the all LED's in panel is in good condition with continues buzzer tone.

CURSOR KEY: The cursor keys '◀▶' (Left/Right) key is used to move the menu list and to toggle between the options in the menu list.

ALPHANUMERIC KEYS:

- ✓ These keys are used for entering the names etc. and numbers.
- ✓ '*' Key is used to go back the previous screen in programming mode.
- ✓ '#' key is used to change the status of modes.

5.2 Status LED:

Normal: In the Normal Condition, **SYSTEM ON, A.C. ON, BATTERY ON & CHARGER ON** green LED will be illuminated. There should be **no other amber / red LED visual indication or audible tone.**

SYSTEM ON: This LED will glow when the panel is energized by primary or standby power. The LCD Display as shown below.



A.C ON: This indication shows the panel is powered with AC supply. Whenever the Main Supply (220v A.C) fails / fuse blown, the A.C.ON LED will be shut off and it also indicated in LCD with toggle Buzzer tone.

BATTERY ON: This indication shows that the battery (secondary) is connected with panel. Whenever the backup battery fails / fuse blown, the battery ON will be shut off and it also indicated in LCD with toggle Buzzer tone.

CHARGER ON: The Charger on LED is used to show the battery charging circuit condition. During charger fail/fuse blown, the charger ON LED will be shut off and it also indicated in LCD with toggle buzzer tone.

SILENCED: This LED will glow when the silence key is pressed in fire condition only.

SUPERVISORY: This supervisory LED will glow when any one or more of the zones of any panel are in supervisory condition.

FIRE: This fire LED will glow when any one or more of the zones of any panel are in fire condition.

FAULT: This fault LED will glow when any one or more of the zones of any panel are in fault condition.

5.3 Operation

5.3.1 Normal Monitoring mode:

Normal Mode is the standard mode of operation. In this mode, the panel continuously monitors system status. When no fire or supervisory or trouble(fault) conditions exist, all LEDs will be off except the System On, AC On, Battery On and Charger On LED. The Notification Appliance Circuits will be off, all relays are in their normal state and the onboard buzzer will be off. When the system is in normal condition the LCD screen of Main panel [RE-2554, 2558] and repeater panel will be as below.



5.3.2 Fire Alarm Condition:

When the control panel [RE-2554, 2558] detects Fire via the Detector / MCP, the repeater panel will cause the following:

- ✓ Turn on the NAC's.
- ✓ Turn on the panel buzzer with continuous tone.
- ✓ Turn on the fire relay.

✓ Turn on the Fire LED.

The LCD screen for three panels [RE-2554, 2558] will be as below.

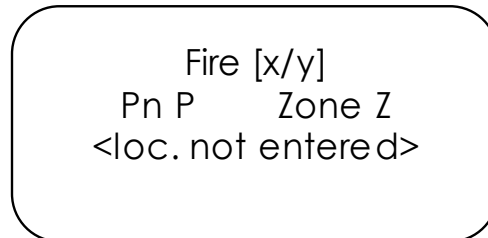

*The above screen **Pn P** does not take place for RE-2554 / RE-2558.*

X – index no. of fire event; **Y** – Total no. of fire events;

Pn – Panel; **P**- Denotes the Panel Address.

Zone **Z** – Denotes the zone number who's programmed site specific location can be viewed by pressing '#' key.

To change the other indexed fire event zones which are suppressed use right / left arrow keys.

For multiple Fire, the LCD screen will be also as shown above.

Restoral:To Silence the NAC's connected in the repeater panel use the Silence Key. This Silence key will work only for Repeater panel's NAC's. After silencing the repeater panel will perform the following in the panel;

- Turn off the Internal Buzzer.
- Turn off the External NAC's.
- Turn on the silenced LED in the repeater panel only.

NOTE:-

- While Pressing the Silence key in the Main panel, it will silence the both NAC's in main panel and repeater panel.
- By pressing the silence key in Repeater panel , it silences the NAC's connected in Repeater & Main panel.

5.3.3 Supervisory:

When the main panel detects supervisory signal via the any normally open contact devices, the repeater panel will replicate the same in the repeater panel.

- ✓ Turn on the panel buzzer with toggle tone.
- ✓ The common supervisory LED will glow.

The LCD screen for panel model [RE-2554, RE-2558] will be as below.

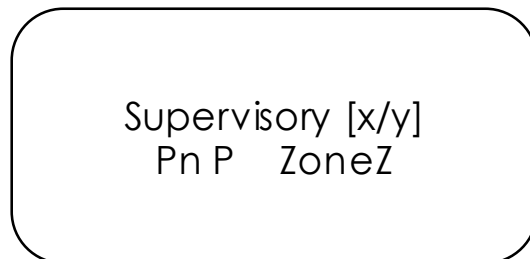

The above screen **Pn P** does not take place for RE-2554/RE-2558.

In case of multiple zone supervisory, the origin zone and recent zone supervisory LED will be viewed in LCD screen is same as above.

X – index no. of supervisory event; **Y** – Total no. of supervisory events; **Pn** – Panel; **P**- Denotes the Panel Address.

Zone **Z** – Denotes the zone number who's programmed site-specific location shown in the repeater display screen.

To change the other indexed supervisory event zones which are suppressed use right / left arrow keys.

Restoral:When the supervisory condition is cleared and Reset key has been pressed after entering the user or admin password if the zones are programmed for latching, the [RE-2554, RE-2558]panel will perform the following:

- Turn off the supervisory LEDs.
- Turn off the panel buzzer.

The LCD screen of repeater panel will be as below.
This LCD Screen will replicate in the Repeater panel.



5.3.4. Fault:

The fault may any one of the following Zone fault / disable / earth fault, NAC fault and power section fault on the Main/repeater panel it will replicate in the repeater panel via RS485 communication. The repeater panel will perform the following

- Turn on the common fault LED.
- Turn on the panel buzzer tone with intermittent buzzer tone (pulse 0.5sec ON and 5sec OFF).

The LCD screen for (RE-2554, RE-2558) will be as below.

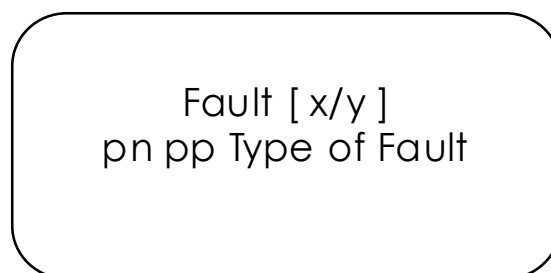

The above screen **PnPP** does not take place for RE-2554/RE2558.

x – nth no. of events; **y** – Total no. of events.

PP- Address of panels

For Multiple fault events the LCD screen will be as shown above.

Restoral:When the fault condition is cleared, the repeater panel will perform the following automatically:

Turn off the fault LEDs.

- Turns off the buzzer tone.
- Deactivate the fault relay.

The LCD screen for RE-2554, RE-2558 will be as below.



Note: The Fault occurred will not affect the other normal functions of the panel

5.3.5. Zone Isolation :The Zone Isolation is done on the main panel; the repeater panel LCD screen will be displayed below.

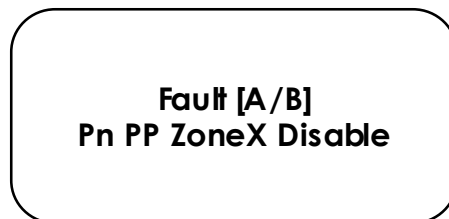

Where **A** – nth Fault; **B** – Total No. of Fault; **X** – Zone Number which is shown in LCD at present

For multiple Fault occurs on the main panel the repeater LCD screen will be same as above.

Chapter 6: Servicing

6.1 Installation/Replacement of PCB:

Remove the screws of PCB, which has to be change and remove the PCB from the mounting position and place the new PCB in that same position as shown below.

Mounting position for Main Circuit board:

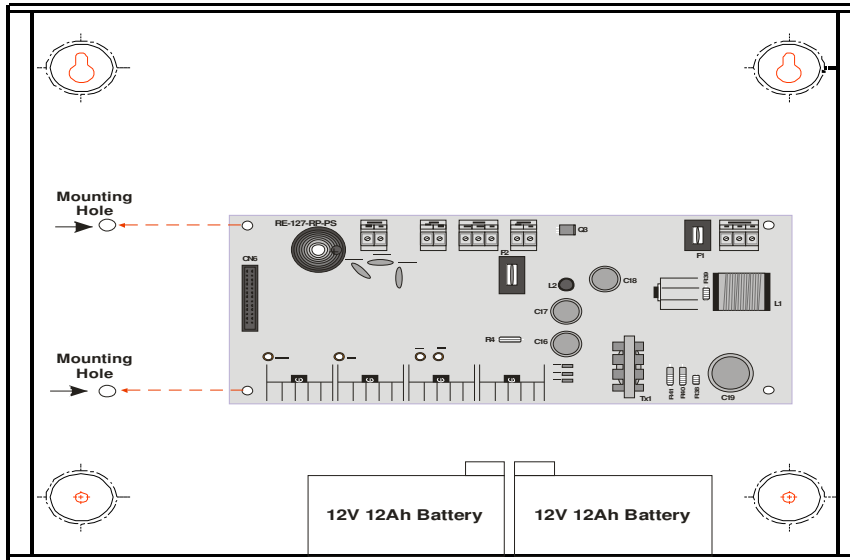

Figure -6

Mounting position for Display board:

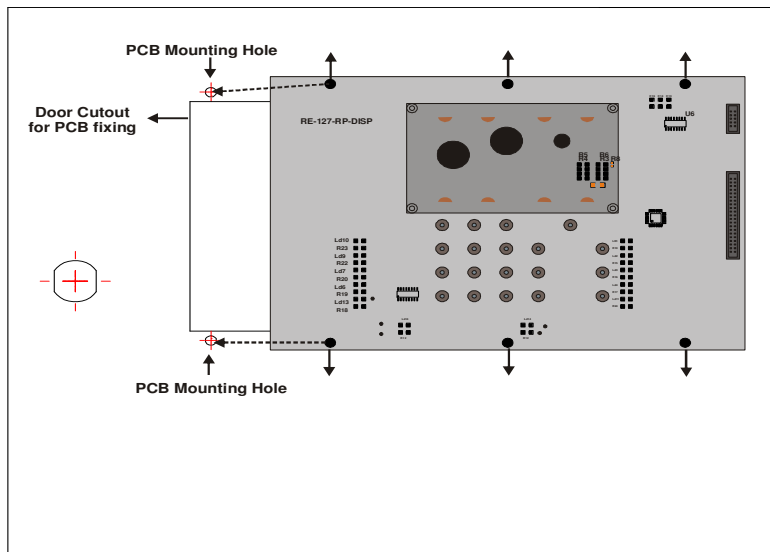

Figure -7

Chapter 7: Battery Calculation

Use Table 7.4 to calculate the total standby and alarm load in ampere hours (AH). This total load determines the battery size (in AH), required to support the control panel under the fail of the AC Power Supply. Complete the table 7.4 as follows:

1. Enter the NFPA standby and alarm times (refer to NFPA requirements below).
2. Calculate the ampere-hours for standby and Alarm, and then sum the standby and alarm ampere-hours.
3. Multiply the sum by the derating factor of 1.2 to calculate the proper battery size (in AH).
4. Write the ampere hour requirements on the protected premises label located inside the cabinet door.

TABLE 7-4: Total Secondary Power Requirements at 24 VDC

System current (**S**) = Quiescent Current = 50mA

Normal Condition : $X = \mathbf{S}$ (Amps) x ____ Hrs. (Backup time required)

$$\mathbf{X=(50 \times 10^{-3}) * 48 \text{hrs} = 2.4}$$

Fire current (**F**) = Max. NAC Current = 600mA @ 5 min [5/60]
=0.0833hr

Alarm Condition : $Y = \mathbf{F}$ (Amps) x ____ Hrs. (Backup time required)

$$\mathbf{Y=(600 \times 10^{-3}) * 0.0833 \text{hr}(5 \text{min})=0.04998}$$

Battery Ah required : $AH = (X + Y) \times 1.2$ (Derating Factor).

$$\mathbf{AH=(2.4 + 0.04998) * 1.2 = 2.939}$$

Note: Refer specification (Page 12) for Quiescent, standby, alarm currents

Chapter 8: Trouble Shooting

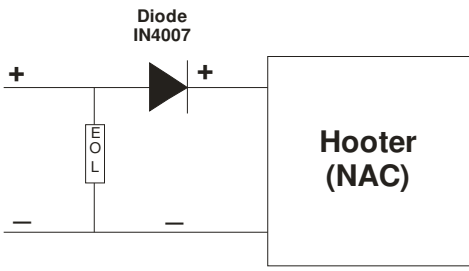
Indication	Root Cause	Remedy
There is no indication on the panel	No power to the Panel	Check AC power and Standby power.
The panel does not repeats the main panel	RS485 Communication cable connected in wrong way.	Check the RS 485 Communication cables A and B are connected in the right way.
Sounder fault indication	There is no proper connection in the sounder Or loop Fault.	If there is no sounder connected to the output, check if EOL resistor connected there or not. Check loop wiring for short / open using a meter.
<p><u>Connection Details for Non Polarized Sounder</u></p> 		<p>If sounder is non-polarized, then ensure each sounder's +ve loop is connected to 1N 4007 diode's cathode and the sounder -ve loop connected to the anode of 1N 4007.</p>

9. Abbreviation

The short forms, which are given in this manual, are abbreviated below,

RE	-	Ravel Electronics
NFPA	-	National Fire Protection Association
AC	-	Alternating Current
DC	-	Direct Current
CRCA	-	Cold Rolled Carbon Alloy
LED	-	Light Emitting Diode
O/P	-	Output
mm	-	millimeter
no(s).	-	number(s)
v	-	volt(s)
Ah	-	Ampereper hour
IEE	-	Institute of Electrical Engineering
EOL	-	End Of Line
PCB	-	Printed Circuit Board
CPU	-	Central Processing Unit
MCP	-	Manual Call Point
S.No	-	Serial Numbers
mA	-	milli Ampere
Kgs	-	kilo grams
C,NO,NC	-	Common, Normally Open, Normally Close.



RAVEL ELECTRONICS PVT. LTD

No. 150-A, Elec. Indsl. Estate, Perungudi, chennai – 600 096. India

Tel.: 24961004 / 24960825 Fax: 044-4204 9599

Email: marketing@ravelfire.com

Web: www.ravelfire.com



DATE:

TEST CERTIFICATE

This is to certify that the following items are tested and checked.
Microprocessor Based Conventional Fire Alarm Repeater Panel.

Model No.: **RE-008R / RE-064RP / RE-128RP**

Serial No.:

No. of zones:

For **RAVEL ELECTRONICS PVT.LTD,**

Q.C. – Engineer

Tested By



RAVEL ELECTRONICS PVT. LTD

No. 150-A, Elec. Indsl. Estate, Perungudi, Chennai – 600 096. India

Tel.: 24961004 / 24960825 Fax: 044-4204 9599

Email: marketing@ravelfire.com

Web: www.ravelfire.com



WARRANTY CERTIFICATE

Model No.: RE-008RP / RE-064RP / RE-128RP

Serial No.:

Ravel Electronics warrants each product to be free from defects in material and workmanship. This obligation is limited to servicing or part returned to the company for that purpose and making good any parts thereof which shall be within warranty period, returned to the company under a written intimation and which to the company's satisfaction to be found defective. The company reserves the right to decide the workplace for the repair work. The freight for defective material will have to be borne by the purchaser, and the transit risk for such material will rest with the purchaser.

This warranty will last for a period of **12 months** from the date of Invoice of the product from the factory. The warranty is applicable only if the product is used within its specifications. The warranty for the replaced components will lapse along with that of the main product.

THIS WARRANTY IS VALID UP TO: 12 months from the date of invoice

Authorised Signatory

Ravel Electronics Pvt Ltd.,

150A, Electronic Industrial Estate,
Perungudi, Chennai – 600096, India.

Web: www.ravelfire.com

Email: marketing@ravelfire.com