



MONITI

Analogue Addressable
Fire Alarm Panel

Alarm System Limitations

An automatic fire alarm system—typically made up of smoke detectors, heat detectors, manual Call Points, audible warning devices, and a fire alarm control with remote notification capability—can provide early warning of a developing fire. Such a system, however, does not assure protection against property damage or loss of life resulting from a fire. The Manufacturer recommends that smoke and/or heat detectors be located throughout a protected premise following the recommendations of the current edition of the National Fire Protection Association Standard 72 (NFPA 72), manufacturer's recommendations, State and local codes, and the recommendations contained in the Guide for Proper Use of System Smoke Detectors, which is made available at no charge to all installing dealers. A study by the Federal Emergency Management Agency (an agency of the United States government) indicated that smoke detectors may not go off in as many as 35% of all fires. While fire alarm systems are designed to provide early warning against fire, they do not guarantee warning or protection against fire. A fire alarm system may not provide timely or adequate warning, or simply may not function, for a variety of reasons:

Smoke detectors may not sense fire where smoke cannot reach the detectors such as in chimneys, in or behind walls, on roofs, or on the other side of closed doors. Smoke detectors also may not sense a fire on another level or floor of a building. A second-floor detector, for example, may not sense a first-floor or basement fire.

Particles of combustion or "smoke" from a developing fire may not reach the sensing chambers of smoke detectors because:

- Barriers such as closed or partially closed doors, walls, or chimneys may inhibit particle or smoke flow.
- Smoke particles may become "cold," stratify, and not reach the ceiling or upper walls where detectors are located.
- Smoke particles may be blown away from detectors by air outlets.
- Smoke particles may be drawn into air returns before reaching the detectors.

The amount of "smoke" present may be insufficient to alarm smoke detectors. Smoke detectors are designed to alarm at various levels of smoke density. If such density levels are not created by a developing fire at the location of detectors, the detectors will not go into alarm.

Smoke detectors, even when working properly, have sensing limitations. Detectors that have photoelectronic sensing chambers tend to detect smoldering fires better than flaming fires, which have little visible smoke. Detectors that have ionizing-type sensing chambers tend to detect fast-flaming fires better than smoldering fires. Because fires develop in different ways and are often unpredictable in their growth, neither type of detector is necessarily best and a given type of detector may not provide adequate warning of a fire.

While a fire alarm system may lower insurance rates, it is not a substitute for fire insurance!

Heat detectors do not sense particles of combustion and alarm only when heat on their sensors increases at a predetermined rate or reaches a predetermined level. Rate-of-rise heat detectors may be subject to reduced sensitivity over time. For this reason, the rate-of-rise feature of each detector should be tested at least once per year by a qualified fire protection specialist. *Heat detectors are designed to protect property, not life.*

IMPORTANT! *Smoke detectors must be installed in the same room as the control panel and in rooms used by the system for the connection of alarm transmission wiring, communications, signaling, and/or power.* If detectors are not so located, a developing fire may damage the alarm system, crippling its ability to report a fire.

Audible warning devices such as bells may not alert people if these devices are located on the other side of closed or partly open doors or are located on another floor of a building. Any warning device may fail to alert people with a disability or those who have recently consumed drugs, alcohol or medication.

Please note that:

- Strobes can, under certain circumstances, cause seizures in people with conditions such as epilepsy.
- Studies have shown that certain people, even when they hear a fire alarm signal, do not respond or comprehend the meaning of the signal. It is the property owner's responsibility to conduct fire drills and other training exercise to make people aware of fire alarm signals and instruct them on the proper reaction to alarm signals.
- In rare instances, the sounding of a warning device can cause temporary or permanent hearing loss.

A fire alarm system will not operate without any electrical power. If AC power fails, the system will operate from standby batteries only for a specified time and only if the batteries have been properly maintained and replaced regularly.

Equipment used in the system may not be technically compatible with the control. It is essential to use only equipment listed for service with your control panel.

The most common cause of fire alarm malfunction is inadequate maintenance. To keep the entire fire alarm system in excellent working order, ongoing maintenance is required per the manufacturer's recommendations, IS, UL and NFPA standards. At a minimum, the requirements of NFPA 72 shall be followed. Environments with large amounts of dust, dirt or high air velocity require more frequent maintenance. A maintenance agreement should be arranged through the local manufacturer's

representative. Maintenance should be scheduled monthly or as required by National and/or local fire codes and should be performed by authorized professional fire alarm installers only. Adequate written records of all inspections should be kept.

WARNING – Several different sources of power can be connected to the fire alarm control panel. Disconnect all sources of power before servicing. Control unit and associated equipment may be damaged by removing and / or inserting cards, modules, or interconnecting cables while the unit is energized. Do not attempt to install, service, or operate this unit this manual is read and understood.

CAUTION – System Reacceptance Test after software changes. To ensure proper system operation, this product must be tested in accordance with NFPA 72 after any programming operation or change in site-specific software. Re-acceptance testing is required after any change, addition or deletion of the system components or after any modification, repair or adjustment to system hardware or wiring.

All components, circuits, system operations, or software functions known to be affected by a change must be 100% tested. In addition, to ensure that other operations are not inadvertently affected, at least 10% of initiating device that are not directly affected by the change, upto maximum of 50 devices, must also be tested and proper system operation verified.

This system meets NFPA requirements for indoor dry operation at 0-49° C/32-120° F and at a relative humidity of 93 ±2% RH (non-condensing) at 32 ±2° C/90 ±3° F. However, the useful life of the system's standby batteries and the electronic components may be adversely affected by extreme temperature ranges and humidity. Therefore, it is recommended that this system and all peripherals be installed in an environment with a nominal room temperature of 15-27° C/60-80° F.

Verify that wire sizes are adequate for all initiating and indicating device loops. Refer to manual Specifications section for maximum allowable I.R. drop from the specified device voltage.

Like all solid state electronic devices, this system may operate erratically or can be damaged when subjected to lightning-induced transients. Although no system is completely immune from lightning transients and interferences, proper grounding will reduce susceptibility. *Overhead or outside aerial wiring is not recommended, due to an increased susceptibility to nearby lightning strikes.* Consult with the Technical Services Department if any problems are anticipated or encountered.

Disconnect AC power and batteries prior to removing or inserting circuit boards. Failure to do so can damage circuits.

Remove all electronic assemblies prior to any drilling, filing, reaming, or punching of the enclosure. When possible, make all cable entries from the sides or rear. Before making modifications, verify that they will not interfere with battery, transformer, and printed circuit board location.

Do not tighten screw terminals more than 9 in-lbs. Over-tightening may damage threads, resulting in reduced terminal contact pressure and difficulty with screw terminal removal.

This system contains static-sensitive components.

Always ground yourself with a proper wrist strap before handling any circuits so that static charges are removed from the body. Use static-suppressive packaging to protect electronic assemblies removed from the unit.

Follow the instructions in the installation, operating, and programming manuals. These instructions must be followed to avoid damage to the control panel and associated equipment. FACP operation and reliability depend upon proper installation by authorized personnel.

Cautions and Warnings



READ AND SAVE THESE INSTRUCTIONS. Follow the instructions in this installation manual. These instructions must be followed to avoid damage to this product and associated equipment. Product operation and reliability depends upon proper installation.



DO NOT INSTALL ANY PRODUCT THAT APPEARS DAMAGED. Upon unpacking your equipment, inspect the contents of the carton for shipping damage. If damage is apparent, immediately file a claim with the carrier.



ELECTRICAL HAZARD - Disconnect electrical field power when making any internal adjustments or repairs. Servicing should be performed by qualified personnel.

STATIC HAZARD - Static electricity can damage components. Therefore, handle as follows:

- Ground yourself before opening or installing components
- Prior to installation, keep components wrapped in anti-static material at all times.



RADIO FREQUENCY ENERGY - This equipment generates, uses, and can radiate radio frequency energy and if not installed and used in accordance with the instruction manual, may cause interference to radio communications. It has been tested and found to comply with the limits for a Class A computing device pursuant to Subpart J of Part 15 of FCC Rules, which are designed to provide reasonable protection against such interference when operated in a commercial environment. Operation of this equipment in a residential area may cause interference in which case the user at his own expense will be required to take whatever measures may be required to correct the interference.

SYSTEM REACCEPTANCE TEST AFTER SOFTWARE CHANGES - To ensure proper system operation, this product must be tested in accordance with NFPA72-1996, Chapter 7 after any programming operation or change in site-specific software. Reacceptance testing is required after any change, addition or deletion of system components, or after any modification, repair or adjustment to system hardware or wiring.

All components, circuits, system operations, or software functions known to be affected by a change must be 100% tested. In addition, to ensure that other operations are not inadvertently affected, at least 10% of initiating devices that are not directly affected by the change, up to a maximum of 50 devices, must also be tested and proper system operation verified.

Table of Contents

Chapter 1: Product Description.....	7
1.1: Feature	8
1.2: Specification	10
1.3: Control and Indication	11
1.3.1: Controls	11
1.3.2: Indication	12
1.3.2.1: LED Indication	12
1.3.2.2: LCD Indication	13
1.3.2.3: Local Buzzer	13
1.4: Circuits	13
1.4.1: Main Circuit Board	13
1.4.2: Input Circuits (SLC)	13
1.4.3: Output Circuit	14
1.4.4: Relays	14
1.5: Components	14
1.6: Mechanical Construction	16
Chapter 2: Installation	19
2.1: Installation Precaution	19
2.2: Panel Mounting	21
2.3: Panel Wiring	22
2.4: Relays	25
2.5: NAC	26
2.6: Signaling Line Circuit (SLC)	26
2.7: UL Power-Limited wiring requirement	30
Chapter 3: Programming	30
3.1: Programming Concept	30
3.1.1: General Comment	30
3.1.2: User Programming	31
3.1.3: Initial Power up	32
3.1.4: Programming Description	32
3.1.5: Programming Password	32
3.2: Programming Instruction	33
3.2.1: Menu Key Flow Diagram	33
3.2.2: Main Menu	40
3.2.2.1: View	40
3.2.2.1.1: Suppressed Events	40
3.2.2.1.2: History	40
3.2.2.1.3: Loop Card	41
3.2.2.2: Program	42
3.2.2.2.1: System	42
3.2.2.2.1.1: Settings.....	42
3.2.2.2.1.1.1: Date & Time.....	43
3.2.2.2.1.1.2: Caption	43
3.2.2.2.1.1.3: Password	43
3.2.2.2.1.1.4: Night Mode.....	44
3.2.2.2.1.2: Relay O/P	46
3.2.2.2.1.3: Advanced	46
3.2.2.2.2: Loop Card	47

3.2.2.2.1: Auto Learn	48
3.2.2.2.2: Status	48
3.2.2.2.3: Style	49
3.2.2.2.4: Device	49
3.2.2.2.4.1: Detector Programming	49
3.2.2.2.4.2: Module Program	50
3.2.2.3: Grouping	51
3.2.2.4: Features	55
3.2.3: Test	57
3.2.4: About	58
Chapter 4: Operating Instruction	59
4.1: Panel Operation	59
4.2: Initial Power up condition	59
4.3: Inputs	59
4.4: Indications	59
4.5: Buzzer	60
4.6: Operating Keys	61
4.7: Normal Monitoring Mode	62
4.8: Alarm Condition	62
4.9: Supervisory Condition	63
4.10: Fault Condition	64
4.11: Test Condition	65
4.12: Disable Condition	65
Chapter 5: Servicing	66
5.1: Installation / Replacement of PCB	66
5.2: Lamp Test	69
5.3: System Power	69
5.4: Trouble Shooting	69
Chapter 6: Battery Calculation	70
Chapter 7: Wiring Requirements	73
Chapter 8: Compatible Devices	73
Chapter 9: Abbreviations	74

Chapter 1: Product Description

The MONITI is a compact, cost effective, intelligent addressable control panel has an extensive list of powerful features. The power supply, master control and indicating boards housed in a FR-ABS Plastic cabinet, providing a complete fire control system for most applications. The panel has maximum capable for Single loop, which is incorporated with the main circuit board. It has the ability to detect total number of detectors and modules connected in a loop. It allows remote and local programming of the control panel using the Monitl-CS upload/download utility. Any personal computer with windows 7 or greater and compatible modem with a speed of 14.4 kbps or faster and Ravel upload/download graphic software kit (Monitl-CS). This allows download of the entire program or upload of the entire program, history file, test data, and current status.

1.1 Features.

- 32 bit processor - Arm Cortex M3.
- Operates on 120 to 220V AC, 60 / 50 Hz.
- Battery Backup 24V DC with Built in charger.
- 40 x 4 Characters LCD display.
- Touch key pad for user friendly operation.
- Loop cards with Class A or B wiring.
- Maximum 147 devices.
- Upto 192 Grouping Facility.
- Auto learning facility.
- Device / Detector wise Configuration facility.
- Auto device type verification.
- 2000 Event storage with Real Time Clock.
- USB 2.0 Interface for PC connectivity.
- Two Programmable Form C relay for Fire, Fault and supervisory.
- One Form C Potential Free relay for Fault
- 24V DC output.
- One Supervised Notification Appliance Circuit.(NAC)

Off Line Programming: Create the entire program in any computer using intelligent ravel software. Upload / download system programming locally.

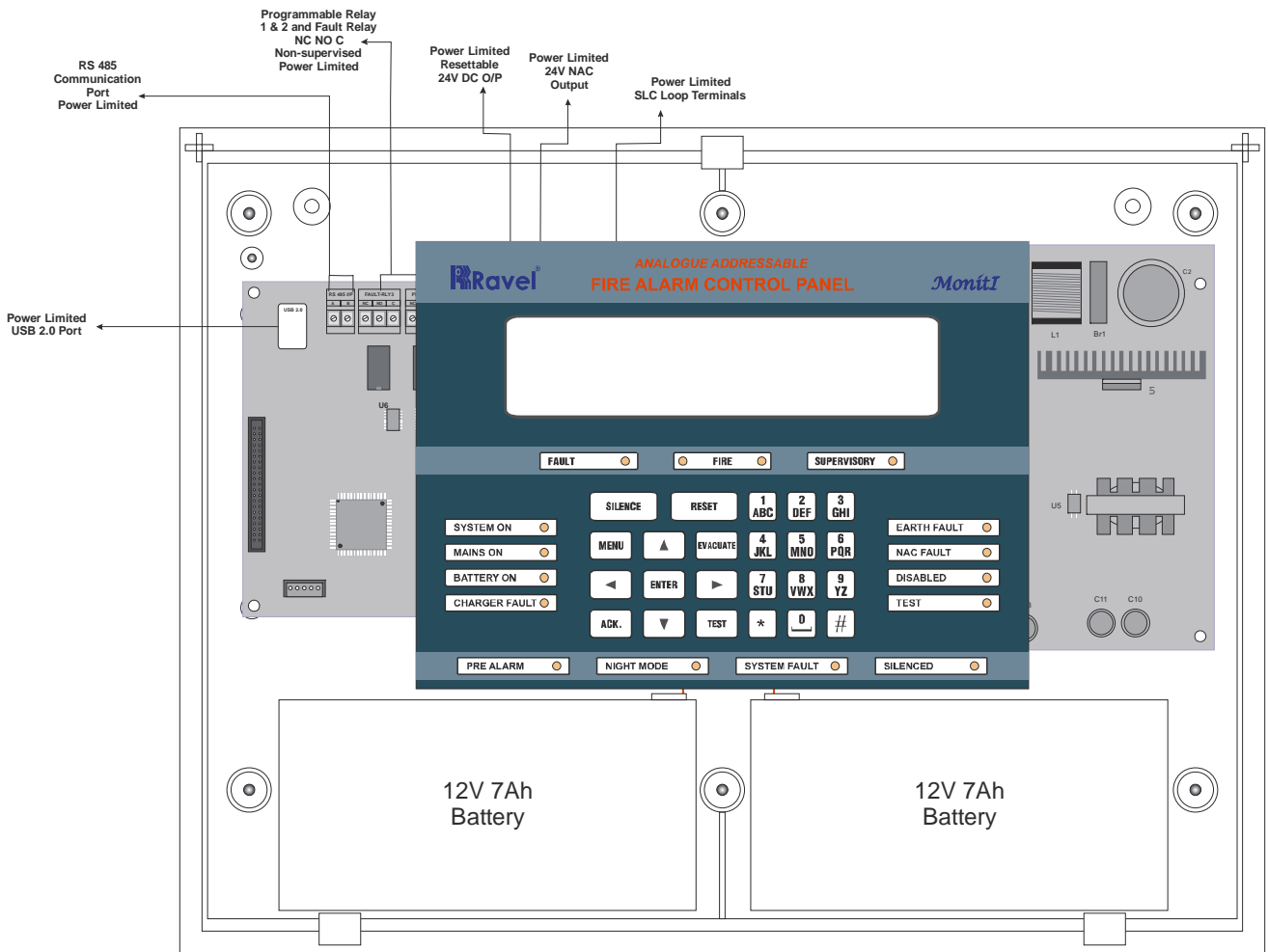

Figure - 1

1.2 Specifications.

Primary Power

120 / 220VAC + 10% -15%, 60 / 50 Hz.

Standby Power

24V D.C (2 Nos of 12v, 7Ah) Sealed Lead acid battery.

Operating Condition

Operating Temperature : 0 - 49° C/32-120° F.

Relative Humidity : 93 ± 2% RH (non-condensing) at 32 ±2° C/96 ±3° F.

Charging Circuit

Charging Voltage – 28V, ± 0.2V Nominal

Charging Current – 0.5A (Max.).

Signaling Line Circuits

Class A or B loop card: 1 No.

No. of Device: 147 No's.

Loop resistance: 40 ohms (Max.(Without Loop Sounder)).

20 ohms (Max.(With Loop Sounder & Maximum Load)).

Loop capacitance: 0.6 µf (Max.).

Loop Current: 300mA (Max.).

Notification Appliance Circuit

Class B, Style - Y wiring

Operating Nominal Voltage: 24 VDC Nominal

Current for NACs: 1.0Amps

Line Drop: 2.4V

End-Of-Line Resistor: 4K7, ½ watt

D.C. Output – Special Application

24VDC, 300mA Max.

Common Three Form – C Relays

Relay Contact Rating: 2Amps @ 30 VDC, 0.5Amps @ 125VAC.

Power Factor: 1.0

1.3 Control and Indications



Figure – 2

1.3.1. Controls:

ACK. Key:

- ✓ To mute local buzzer in alarm condition.
- ✓ To mute local buzzer in Supervisory or fault condition.
- ✓ User or Admin password protected.

SILENCE Key:

- ✓ To silence the external NACs in Fire Condition.
- ✓ User or Admin password protected.

RESET Key:

- ✓ To reset the particular zones in Fire alarm or Latched Supervisory condition.
- ✓ User or Admin password protected.
- ✓ Possible to access only after silence in alarm condition.

EVACUATE:

- ✓ To activate External NACs Manually.
- ✓ User or Admin password protected.

CURSOR KEYS:

- ✓ To move the curse point in the LCD as required.

ENTER Key:

- ✓ To accept the programmed or edited menu, mode or value in the LCD.

MENU Key:

- ✓ To enter into the Main Menu in the LCD.

TEST Key:

- ✓ To enter into the Lamp Test mode.
- ✓ To enter into the self test for individual Device.

ALPHANUMERIC KEYS:

- ✓ These keys are used for entering the names etc. and numbers.
- ✓ '*' Key is used to go back the previous screen in programming mode.
- ✓ '#' is used for the Back Space / Delete the content.

1.3.2. Indications:

1.3.2.1 LED indication

System On – Green
Fire – Red
Fault – Yellow
Supervisory – Yellow
Mains On – Green
Battery On – Green
Charger Fault – Yellow
Earth Fault – Yellow
System Fault – Yellow
Silenced – Yellow
Pre Alarm - Yellow
NAC Fault – Yellow
Test – Yellow
Night – Yellow
Disable – Yellow

1.3.2.2 LCD Indication

The 40X4 Character LCD is used for the programming the panel functions. It also indicates all events along with the LED indications except system on and system fault. Programmed zone wise location details can be viewed.

1.3.2.3 Local Buzzer

A piezo buzzer provides separate and distinct sounds for alarm, trouble and supervisory conditions:

- Alarm – Continuous
- Fault – pulse 0.5sec ON and 5sec OFF
- Supervisory / PreAlarm – pulse 0.25sec ON and 0.25sec OFF

1.4 Circuits

The main circuit board provides system control and visual indication control and contains the system microcontroller, programming part (USB-2.0), non-volatile memory for system events storages. The main circuit board is used for the critical functions like programmable logic and timing functions and non critical functions, like customer area location and device messages.

The visual display board consists of a series LED's for common indication of power, alarm, fault and supervisory. The display board has 40 X 4 characters LCD, which describes for the system information with real time clock and it helps the user to program the system options easily. It also contains matrix touch key pad, which helps the user for friendly access.

1.4.1 Main Circuit Board

The main circuit board controls the display board, SLC loop card, output ports like USB 2.0. The main circuit board contains relay outputs, NAC output etc.,

1.4.2 Input Circuits (SLC)

There is a Single SLC loop is provided with standard on the FACP main circuit board. This SLC loop is configurable for class A style 4, 5 or 7 or class B style B or C. It provides communication to addressable detectors, monitor (initiating device) and controls (output device) modules. These loop cards have redundancy, that is it give fire and alarm outputs like a conventional FACP during the CPU is failed condition.

1.4.3 Output Circuit

The following outputs are available with this FACP:

- 24V DC output for having capacity of 300 mA.
- 24VDC Battery charger up to 40 Ah max.
- One Class B Style Y NACs, 1 Amp each.

1.4.4 Relays

Two programmable and one standard fault Form-C dry contact relays are provided. These two programmable relays are factory default programmed for alarm, prealarm and supervisory. Contacts are 2 Amps @ 30 VDC or 0.5 Amps @ 125VAC.

1.5 Components

The main circuit board contains the system CPU, other primary components wiring interface terminal outputs and inbuilt SLC loop cards in main circuit boards. The inbuilt SLC Loop Card gets the information's from the detectors and modules and provides it into the control panel. This allows the control panel to monitor and process the information to the determine the status (alarm, fault, maintenance or normal) of each detectors and modules. The maximum 127 Devices (Detectors & Modules) and 20 Loop powered sounder shall be connected in this loop card.

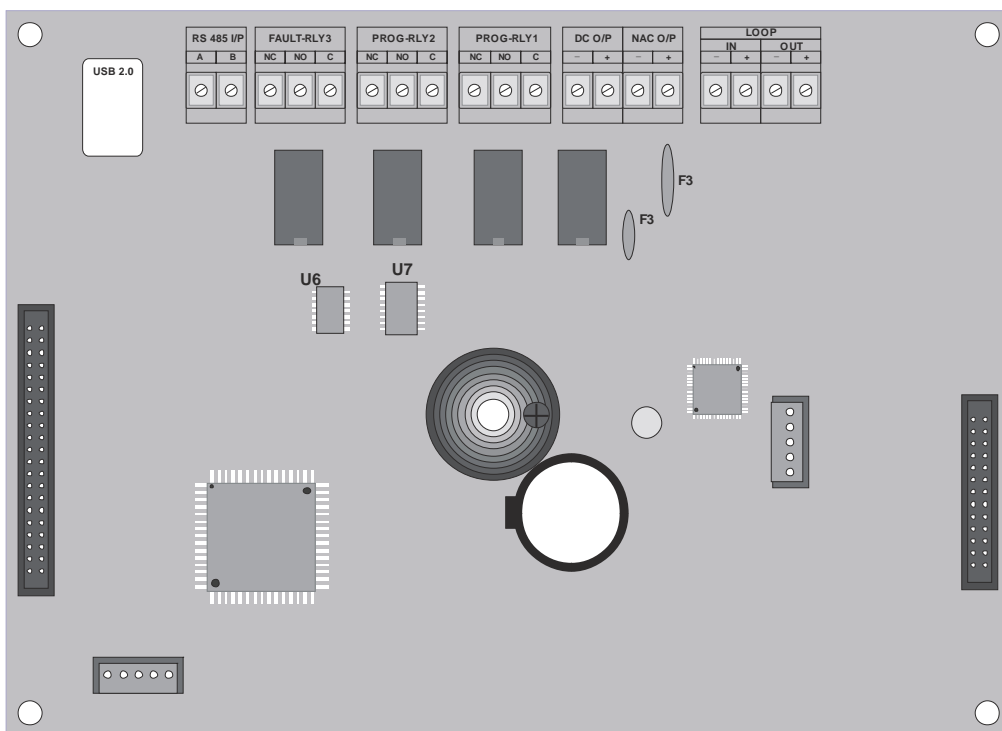

Figure - 3

The display board contains the LED display for common indications and touch key pad.

The power supply gives the power for the main circuit board and for SLC loop cards. It is SMPS type power supply, gives the output for 2 amps max.

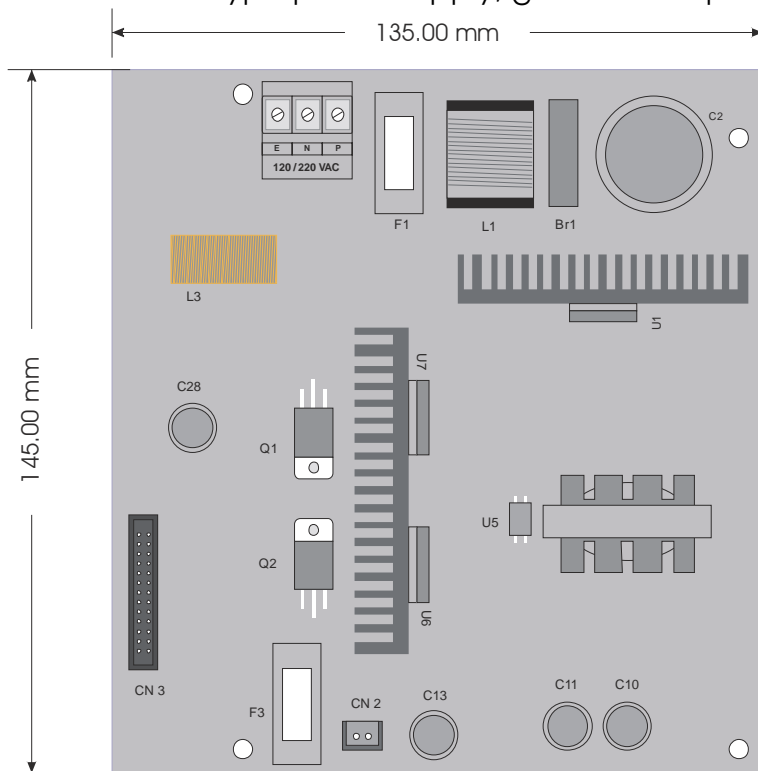

Figure - 4

1.6 Mechanical Construction

The enclosure of the Panel is constructed by FRABS Plastic. The Ø19mm 14 no's of knockouts are given for cable entry at the top of the cabinet. The lockable hinged door is provided to access the inside the cabinet. The panel also has sufficient space to accommodate 2 Nos. of 12v, 7Ah batteries. For higher capacity batteries like 26Ah, 40Ah etc use separate enclosure should be used and installed with conduit in the same room or near the panel.

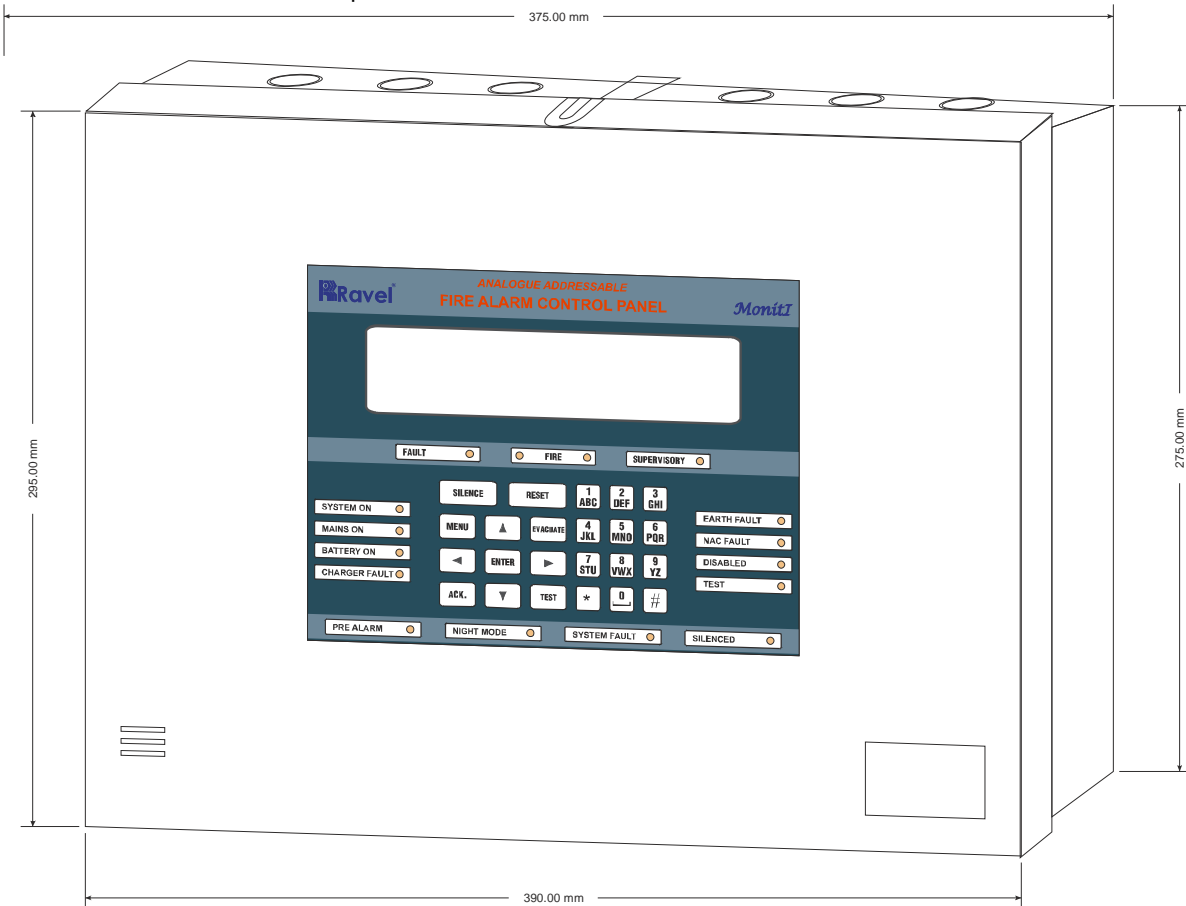

Figure - 5

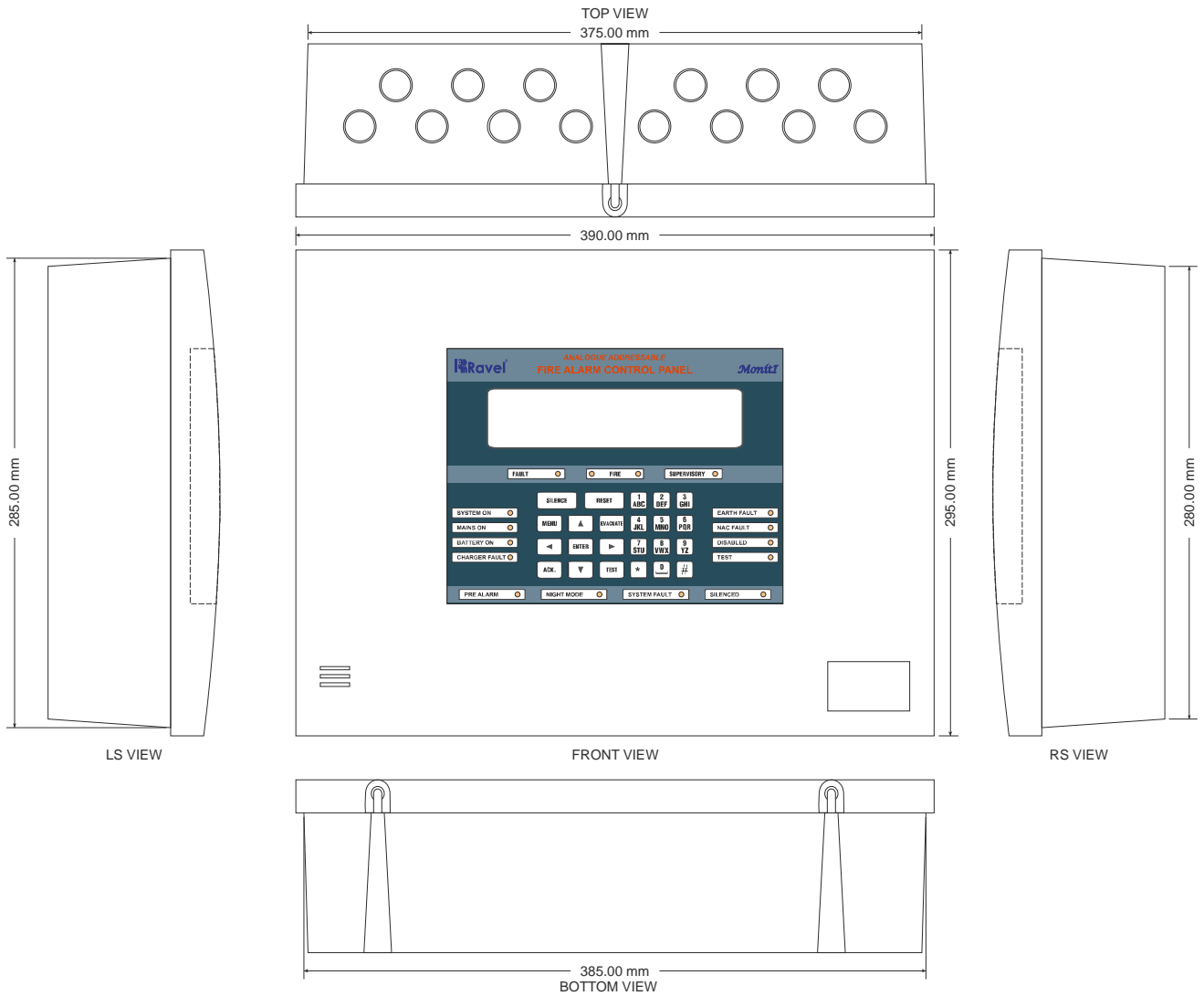

Figure – 6

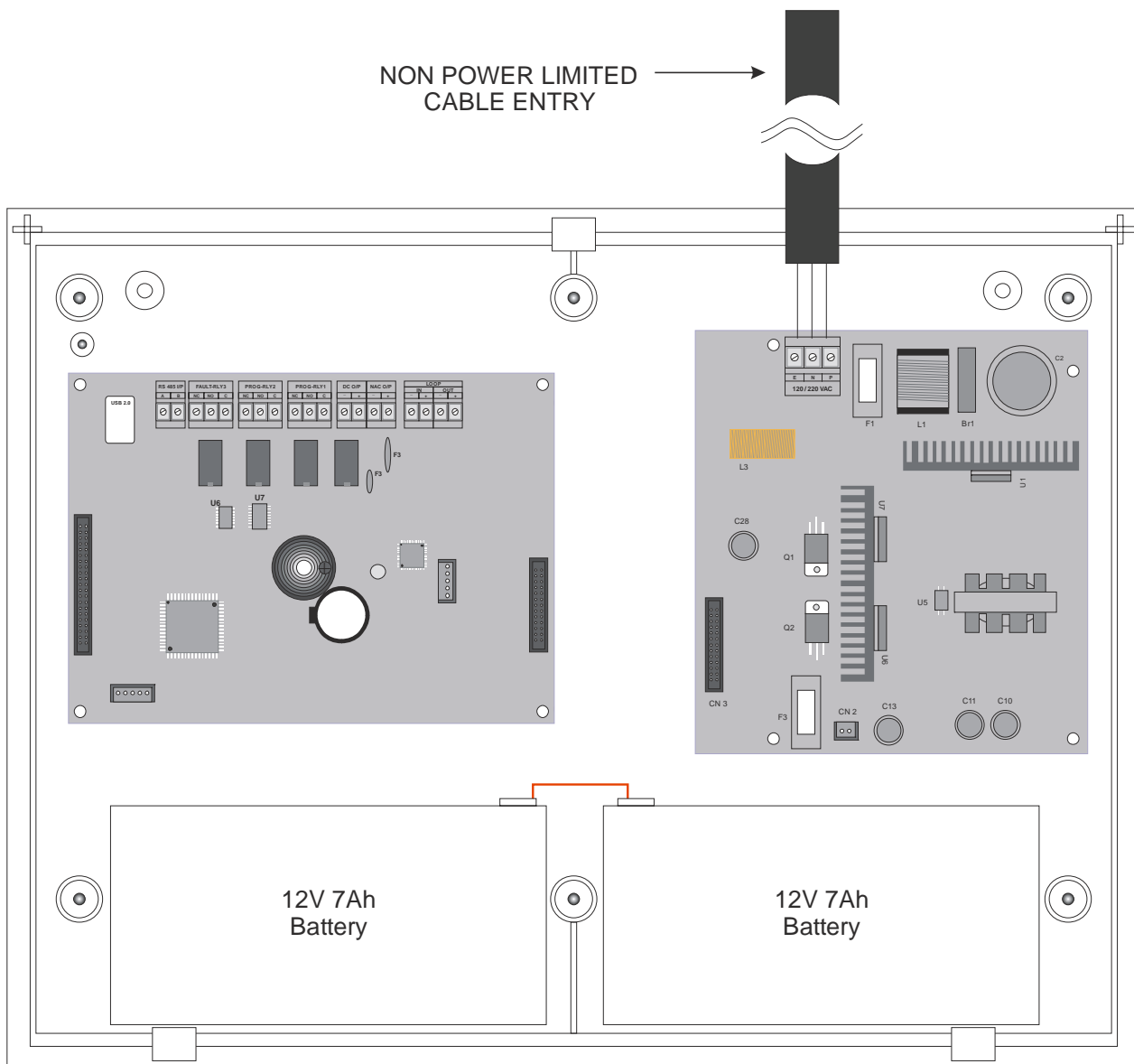

Figure - 7

Chapter 2: Installation

2.1 Installation Precaution

Installation Precautions



WARNING - *Several different sources of power can be connected to the fire alarm control panel. Disconnect all sources of power before servicing. Control unit and associated equipment may be damaged by removing and/or inserting cards, modules, or interconnecting cables while the unit is energized. Do not attempt to install, service, or operate this unit until this manual is read and understood.*



CAUTION - *System Reacceptance Test after Software Changes.* To ensure proper system operation, this product must be tested in accordance with NFPA 72 after any programming operation or change in site-specific software. Reacceptance testing is required after any change, addition or deletion of system components, or after any modification, repair or adjustment to system hardware or wiring. All components, circuits, system operations, or software functions known to be affected by a change must be 100% tested. In addition, to ensure that other operations are not inadvertently affected, at least 10% of initiating devices that are not directly affected by the change, up to a maximum of 50 devices, must also be tested and proper system operation verified.

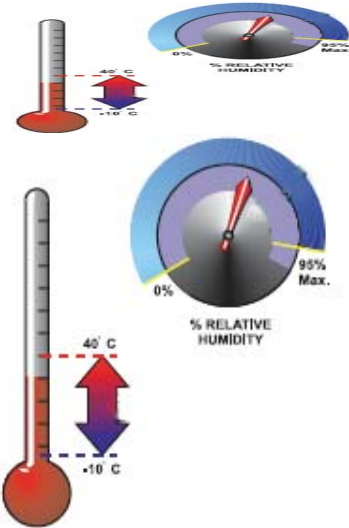

This system meets NFPA requirements for indoor dry operation at 0-49° C/32-120° F and at a relative humidity of 93 ±2% RH (non-condensing) at 35 ±2° C/77 ±3° F. However, the useful life of the system's standby batteries and the electronic components may be adversely affected by extreme temperature ranges and humidity. Therefore, it is recommended that this system and all peripherals be installed in an environment with a nominal room temperature of 15-49° C/60-120° F.

Verify that wire sizes are adequate for all IDC's loops. Most devices cannot tolerate more than a 10% I.R. drop from the specified device voltage. *Adherence to the following will aid in problem-free installation with long-term reliability:*

Like all solid-state electronic devices, this system may operate erratically or can be damaged when subjected to lightning-induced transients. Although no system is completely immune from lightning transients and interferences, proper grounding will reduce susceptibility. *Overhead or outside aerial wiring is not recommended, due to an increased susceptibility to nearby lightning strikes.* Consult with the Technical Services Department if any problems are anticipated or encountered.

Disconnect AC power and batteries prior to removing or inserting circuit boards. Failure to do so can damage circuits.

Remove all electronic assemblies prior to any drilling, filing, reaming, or punching of the enclosure. When possible, make all cable entries from the sides or rear. Before making modifications, verify that they will not interfere with battery, transformer, and printed circuit board location.

Do not tighten screw terminals more than 1.0168 N-m. Over-tightening may damage threads, resulting in reduced terminal contact pressure and difficulty with screw terminal removal.

Though designed to last many years, system components can fail at any time. This system contains static-sensitive components. Always ground yourself with a proper wrist strap before handling any circuits so that static charges are removed from the body. Use static-suppressive packaging to protect electronic assemblies removed from the unit.

Follow the instructions in the installation, operating, and programming manuals. These instructions must be followed to avoid damage to the control panel and associated equipment. FACP operation and reliability depend upon proper installation by authorized personnel.

2.2 Panel Mounting

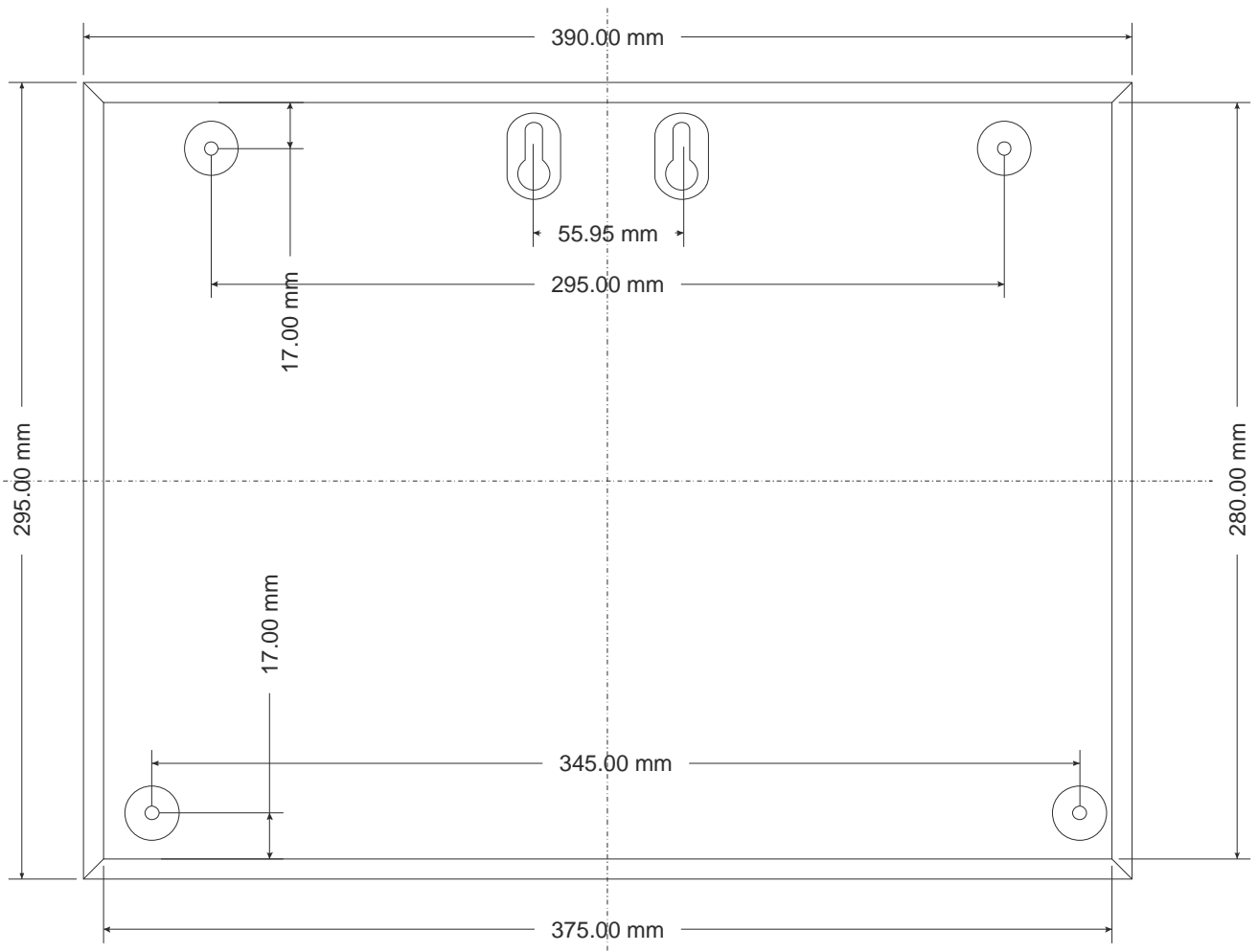

Figure – 8

Remove all the Boards before placing the panel in its mounting position. Place the panel in its mounting position and fix the panel to the wall using the slots of the screws. Ensure the enclosure and the inner parts of the panel are given sufficient protection during installation. Fix the all boards in its position (Refer Figure 18, 19 & 20). All external cables are to be entered via 14 Numbers of $\varnothing 19\text{mm}$ preformed knockouts located at top of the panel.

When the installation of all the cables has been completed, clean the interior of the enclosure ensuring all masonry debris and drilling swords are removed.

2.3 Panel Wiring

Warning: Several different sources of power can be connected to this panel. Disconnect all sources of power before servicing. The panel and associated equipment may be damaged by removing and / or inserting cards, modules or inter connecting while this unit is energized.

Primary Power source (AC) and Earth Ground Connections

AC Power connections are made inside the control panel cabinet. The Primary source for the MONITI is 120/220 VAC, 60/50Hz, 2 Amps. Run a pair of wires with Earth conductor from the protected premises main breaker box to connector (AC Terminal) of the power supply board. As per National Electrical Code, use 14 AWG (2.00 mm², 1.6mm O.D) or heavier gauge wire with 600V insulation. No other equipment may be connected to this circuit. In addition, this circuit must be provided with over current protection and may not contain any power disconnect devices. A separate Earth Ground connection must be made to ensure the proper panel operation and lighting and transient protection. Connect the Earth Ground wire (Min. 14AWG / 2.00 mm²) to the connector CN1.

Standby Power Source (Batteries)

Observe polarity when connecting the battery. Connect the battery cable to connector CN2 on the Power Supply board (RE – MON – PS-R1) using the connector and cable provided. The battery charger is current – limited and capable of recharging sealed lead acid type batteries up to 40Ah.

During alarm condition, the charger section is disconnected from the battery hence there will not be any charging at that time.

Power Supply Circuit Board (RAVEL RE – MON – PS-R1)

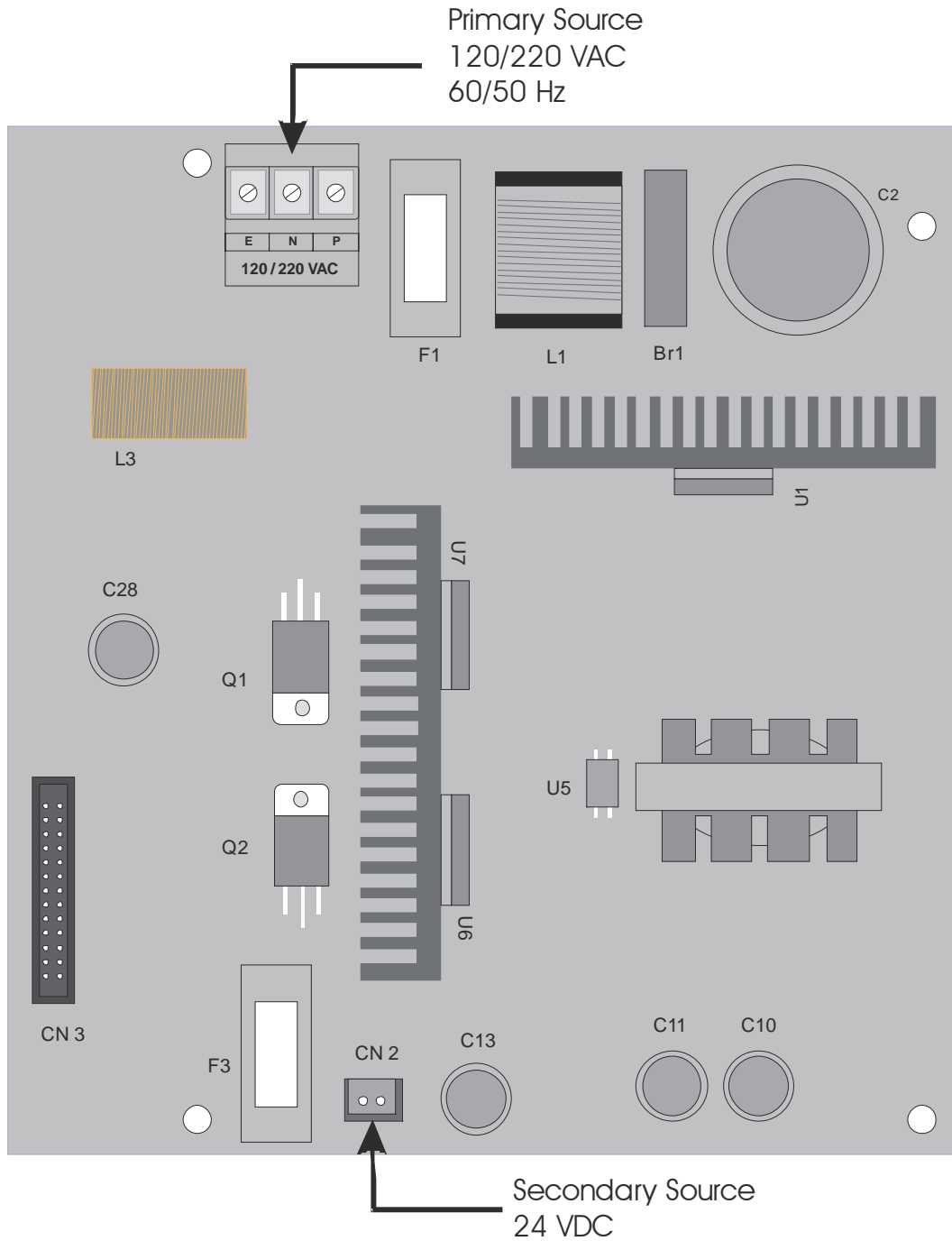

Figure – 9

Master Board (RAVEL RE - MON - MB-R1)

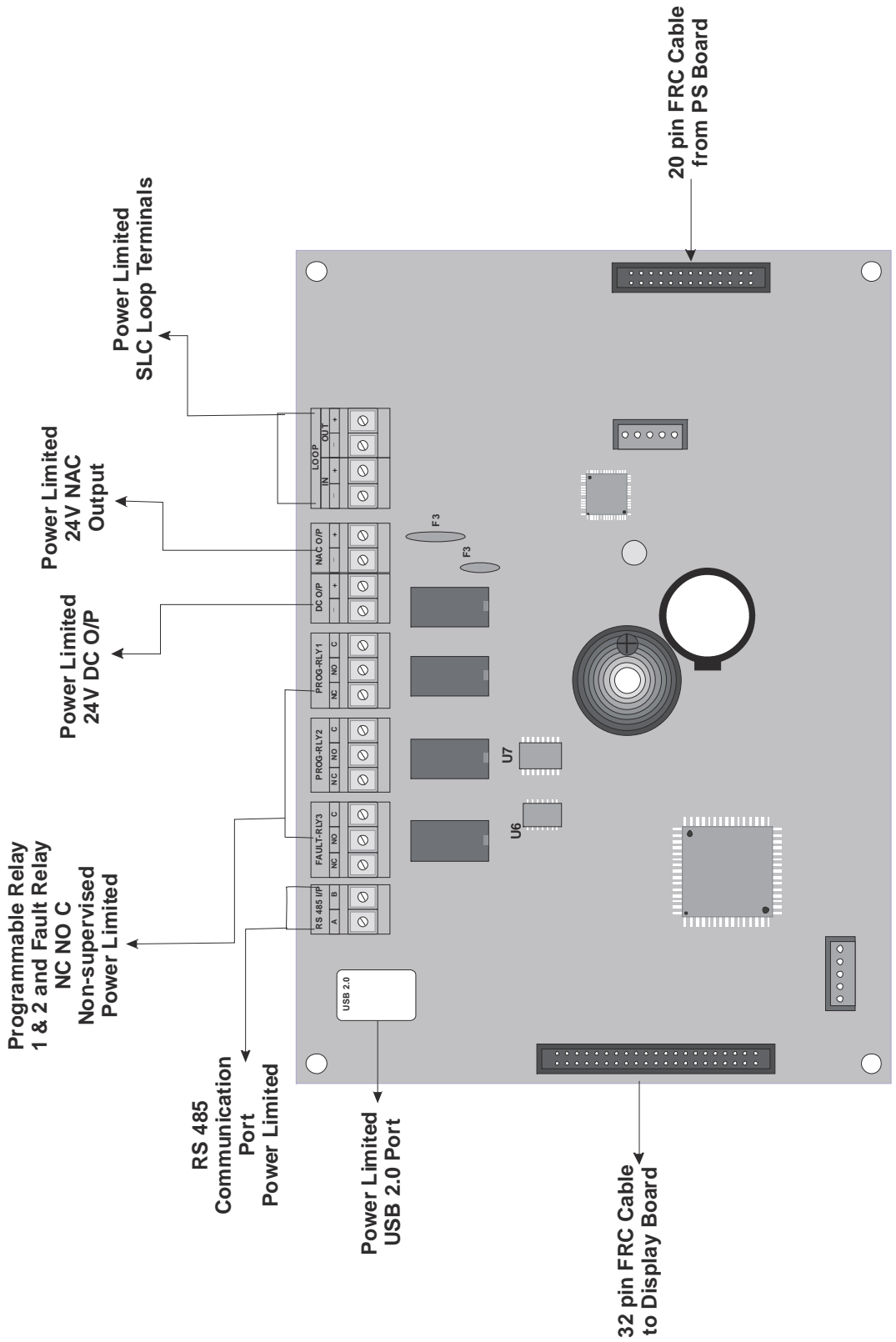

Figure - 10

Field Wiring Diagram

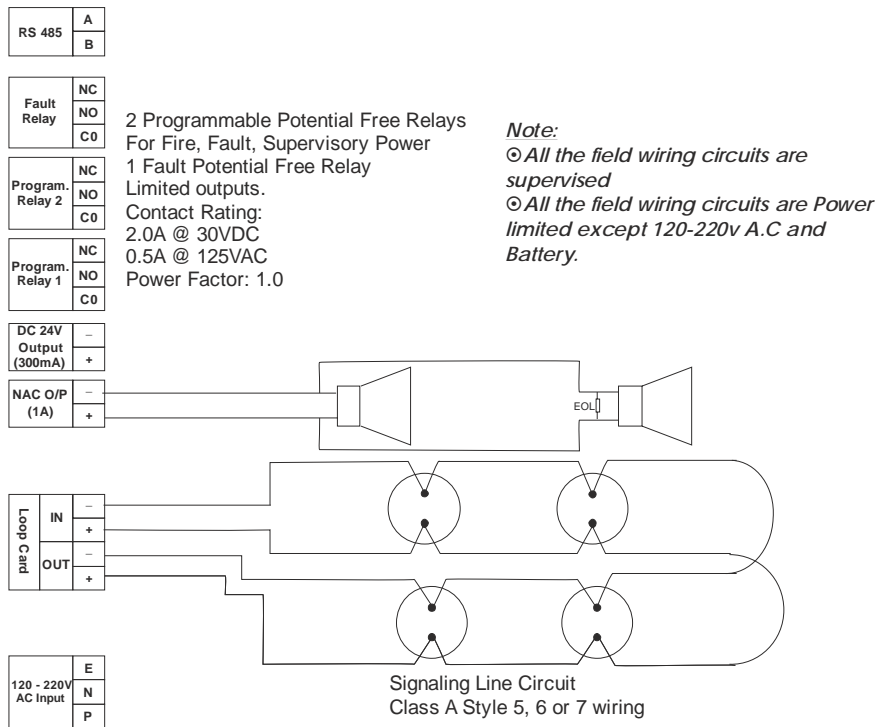

Figure – 11

2.4 Relays

The 2 Form – C programmable relays and 1 Fault Relay are provided in this FACP with the contact rating for 2 Amps @ 30 VDC or 0.5 Amps @ 125 VAC (Resistive Only). The default options for the Programmable Relay 1 as Fire and Relay 2 as Supervisory.

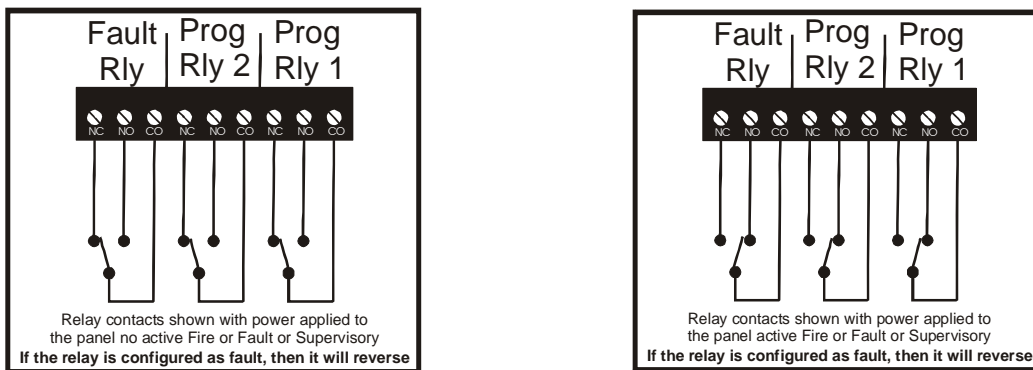

Figure - 12

Note: The relay connections may be power limited or non – power limited, provided that 0.25" spacing is maintained between conductors of power limited and non – power limited circuits.

2.5 NACs

The one Class B Style Y, supervised NAC's are provided with the current rating of 1 Amps. It gives the steady output for NACs (Notification Appliance Circuit) and synchronizing module should be used for strobes.

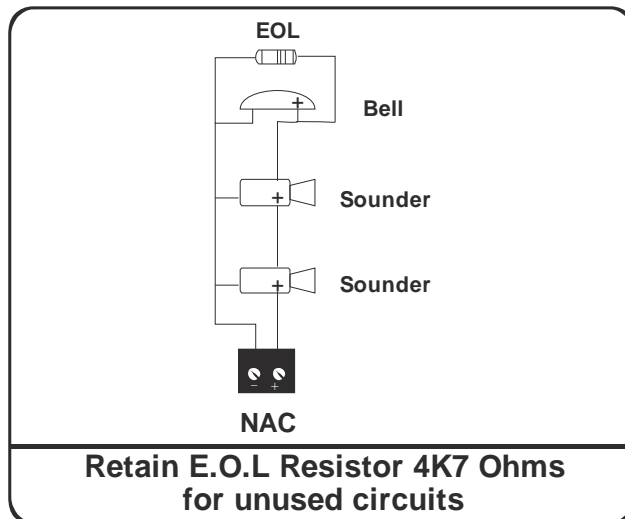

Figure – 13

NOTE:

For Synchronized ANSI Pattern Output External Synchronizing Module to be used. Refer *Chapter 8* for Compatible Devices.

2.6 Signaling Line Circuit (SLC)

No. of Loop Card	:	1
Type	:	Class A or Class B
Wire Size	:	2.5 sq. mm Max.
Loop Resistance	:	20 Ω Max.
Total No. of Devices	:	127 + 20 (Loop Sounders) Devices
Compatible Devices	:	Refer Chapter 8.

The SLC loop configurable for NFPA class A or Class B, provides with communication to addressable detectors, monitor and control modules.

Class B SLC wiring

SLC wiring without Isolator

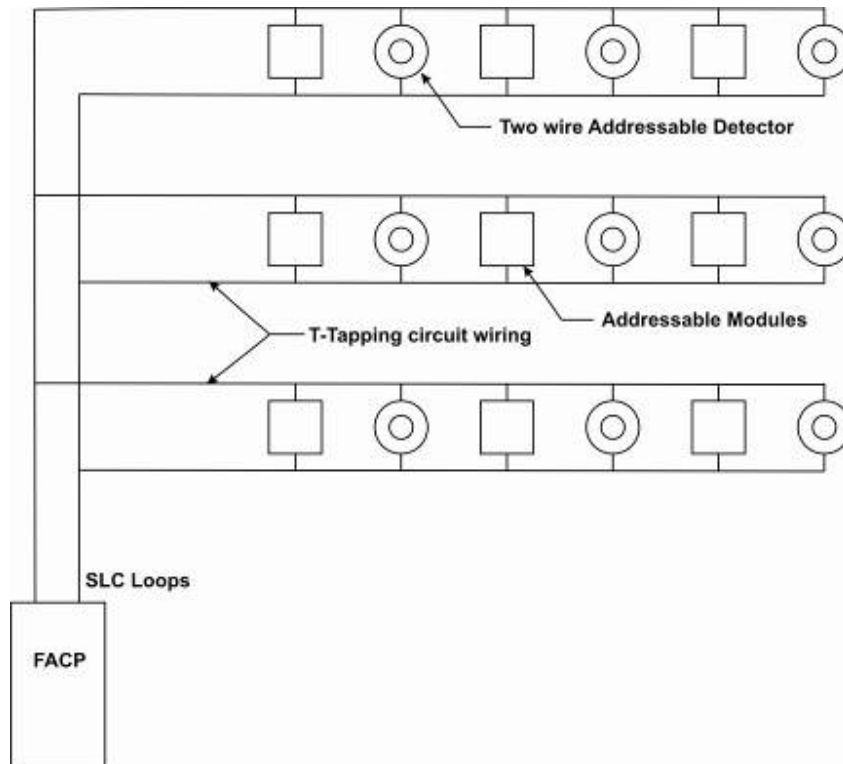

Figure - 14

SLC wiring with Isolator

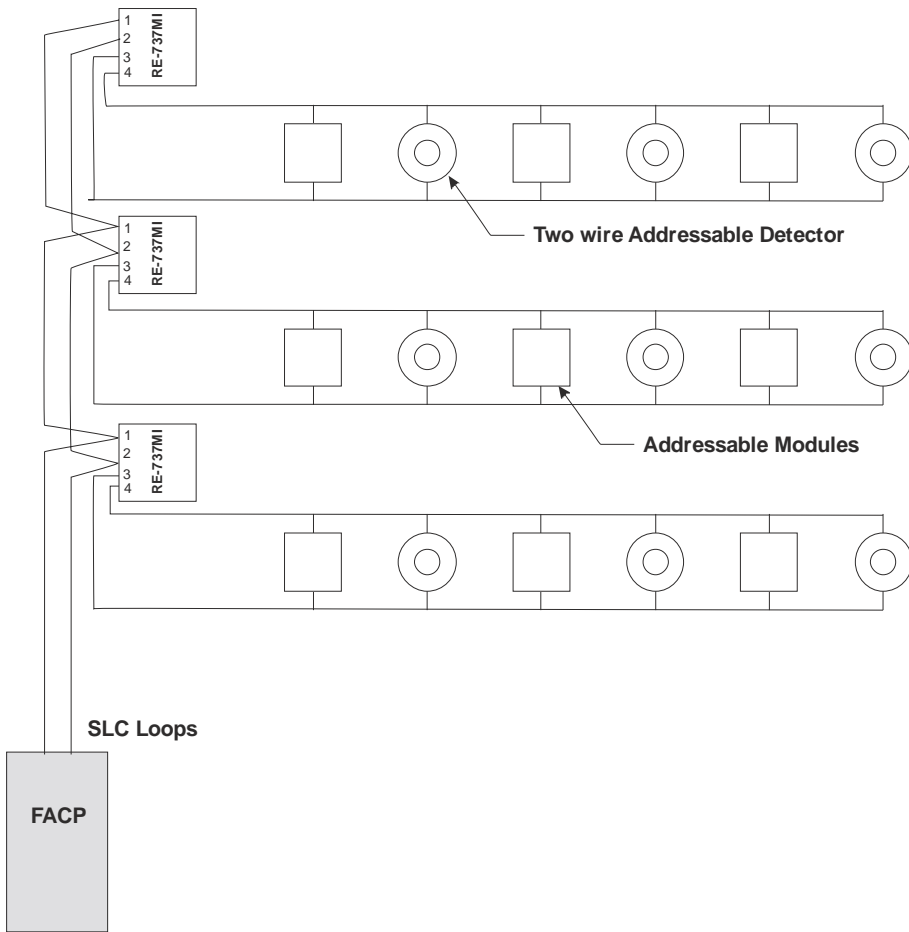

Figure - 15

Class A SLC wiring

SLC wiring without Isolator

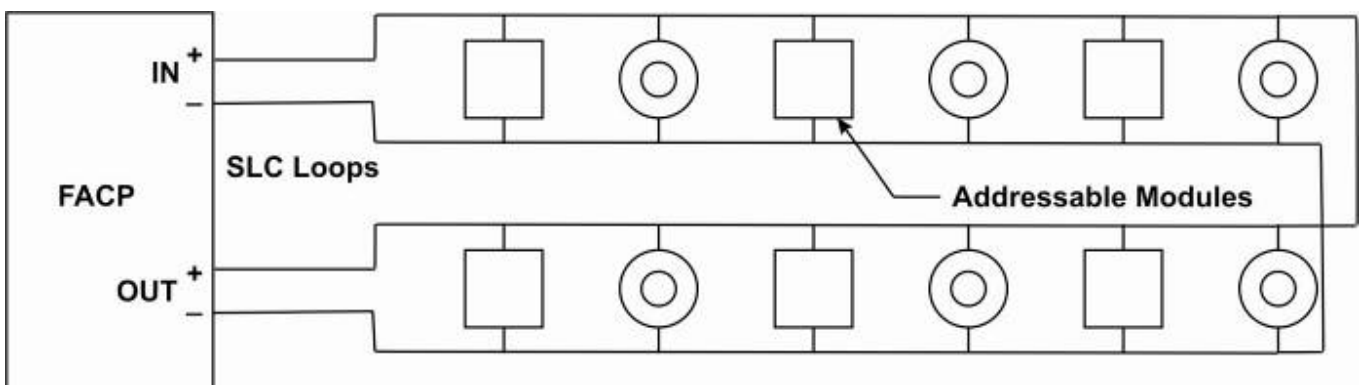

Figure - 16

SLC wiring with Isolator

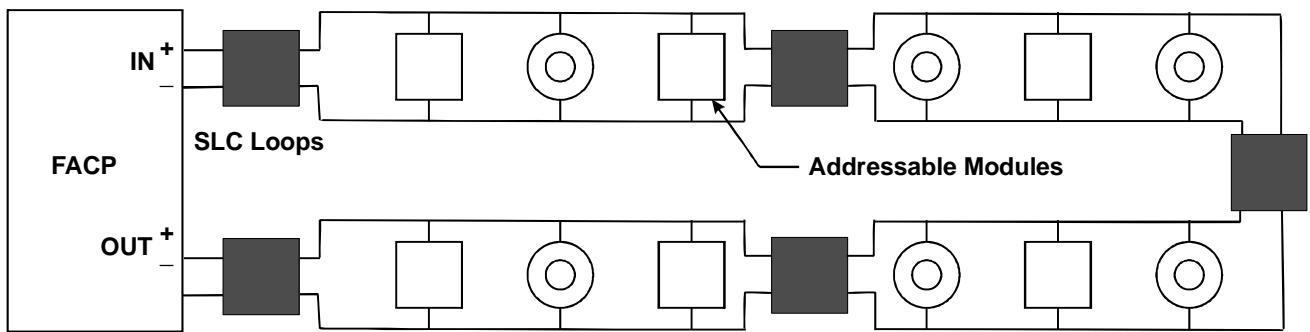

Figure - 17

2.7 Power-limited wiring requirements

The power limited and non-power limited circuit wiring must remain separated in the cabinet. All power limited circuit wiring must remain at least 0.25" (6.35mm) away from any other non- power limited circuit wiring and non-power limited circuit wiring must enter and exit the cabinet through different knockouts and/or conduits as shown in the figure - 7.

Chapter 3: Programming

3.1 programming Concept

Warnings: Before Programming

1. All applicable codes and standards should be considered when the programming the control unit.
2. The Control Unit continues to monitor inputs circuits and devices and acts according to the current program settings if and alarm is received while it is being programmed.
3. Loading a new database erases the current database before loading the new database. If the new database is not loaded after the erase, the panel will not operate.
4. The Database must be completely loaded for it to be considered valid. The program keeps track if the last database load was valid/complete or not. An invalid database load disables the panel until a valid database load is done.

3.1.1 General Comments

Programming can be accomplished using the MONITI keypad or by connecting an optional standard computer keyboard. The keyboard can be connected to the USB 2.0 connector on the control panel main circuit board. The information presented in this section refers to programming the MONITI via the onboard keypad.

3.1.2 User Programming

The MONITI is completely field programmable and requires no special software skill. While programming the MONITI, the fire protection capabilities of the control panel are enabled.

Site specific programming may be accomplished in following ways.

- Auto programming Feature – This is a convenient method for the quickly bringing the FACP addressable SLC devices online without the necessity of programming each device individually. Refer to “Auto Learn” on the Page 19 for a detailed description of Auto programming.
- Manual Programming or editing, using the FACP keypad or a PC keypad

- Off line programming and Editing feature allows creation and editing of site specific custom programs using a windows based computer. For programs requiring a large amount of data entry, this method may be preferred. AVANI-RGS programming kit can be ordered for this purpose.

The system all normal screen will be displayed in a programmed system with no active alarms, troubles or supervisory, as illustrated below.

To access the programming or view the status & history, press menu key, which is shown in LCD as below.

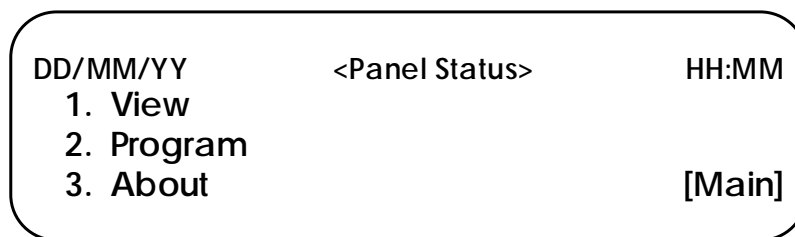

From this menu screen by pressing '1', the panel enters into status/history view mode. It allows user to view the event and program setting of the control panel. The password is not required for this feature.

From this menu screen by pressing '2', the panel enters into programming mode which only can access by the authorized persons. After pressing '2', LCD screen will be in password prompt. After pressing correct password and by pressing enter key, user can select the programming options to change it.

From this menu screen by pressing '3', the panel shows the about the version and revision levels.

Exit from view & Program Mode

The programmer can exit from the view / Program mode by pressing '*'key repeatedly until the "System Healthy" screen.

3.1.3 Initial Power up

Here the initial programming procedure for a new system is described. The same procedure is used for modify the programming settings in existing system.

After completing the wiring of the addressable devices to the SLC, apply power to the control panel. If the addressable devices are not programmed in the Fire Alarm Panel, the following trouble message will be displayed.

3.1.4 Programming Description

By pressing menu key, the view and program options have multiple functions or features which may be chosen. To view all of the choices, it is necessary that the programmer scroll through a number of the additional screen and cursor keys. Refer "Programming Instruction", for additional information of the various screens.

The title of the main option screen will always be displayed at bottom right of the sub-screens. To select the one of the choices in a screen, the programmer presses the keypad numerical key corresponding to the desired choice.

Note: That sub-screen may also have multiple options which require viewing more than one screen. The same process, as detailed in the previous paragraph is followed to view all options.

3.1.5 Programming Password

There is a factory set password which will access the programming screens as indicated in the following examples. From either of the screens, access to specific system and device feature or programming may be obtained. All user programming and entries are stored in the nonvolatile memory. The factory set password can be changed by user. Refer "Password Change" for additional information.

Programming Instruction

3.1.6 Menu Key Flow Diagram

MENU KEY - FLOW DIAGRAM

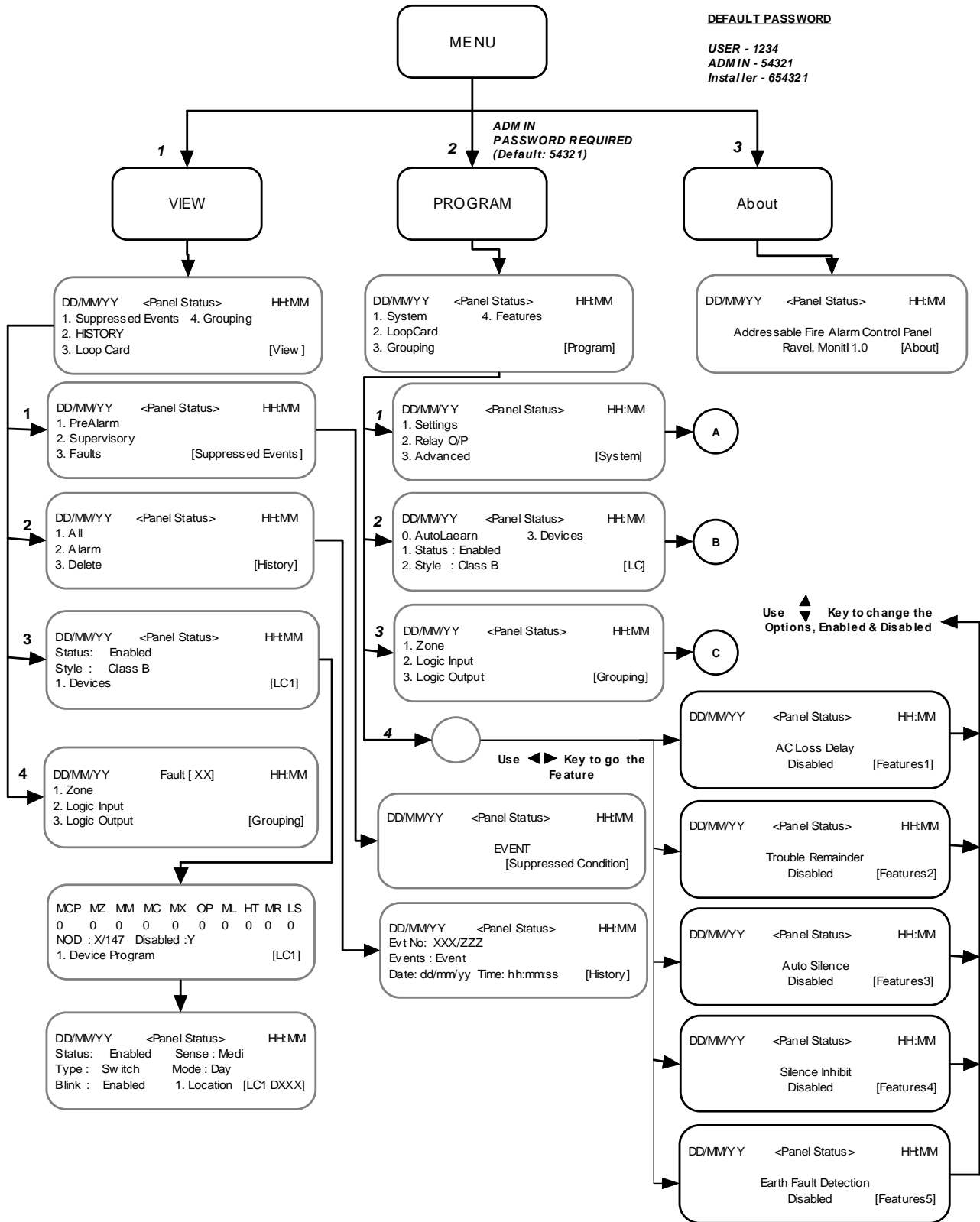

MENU KEY - FLOW DIAGRAM

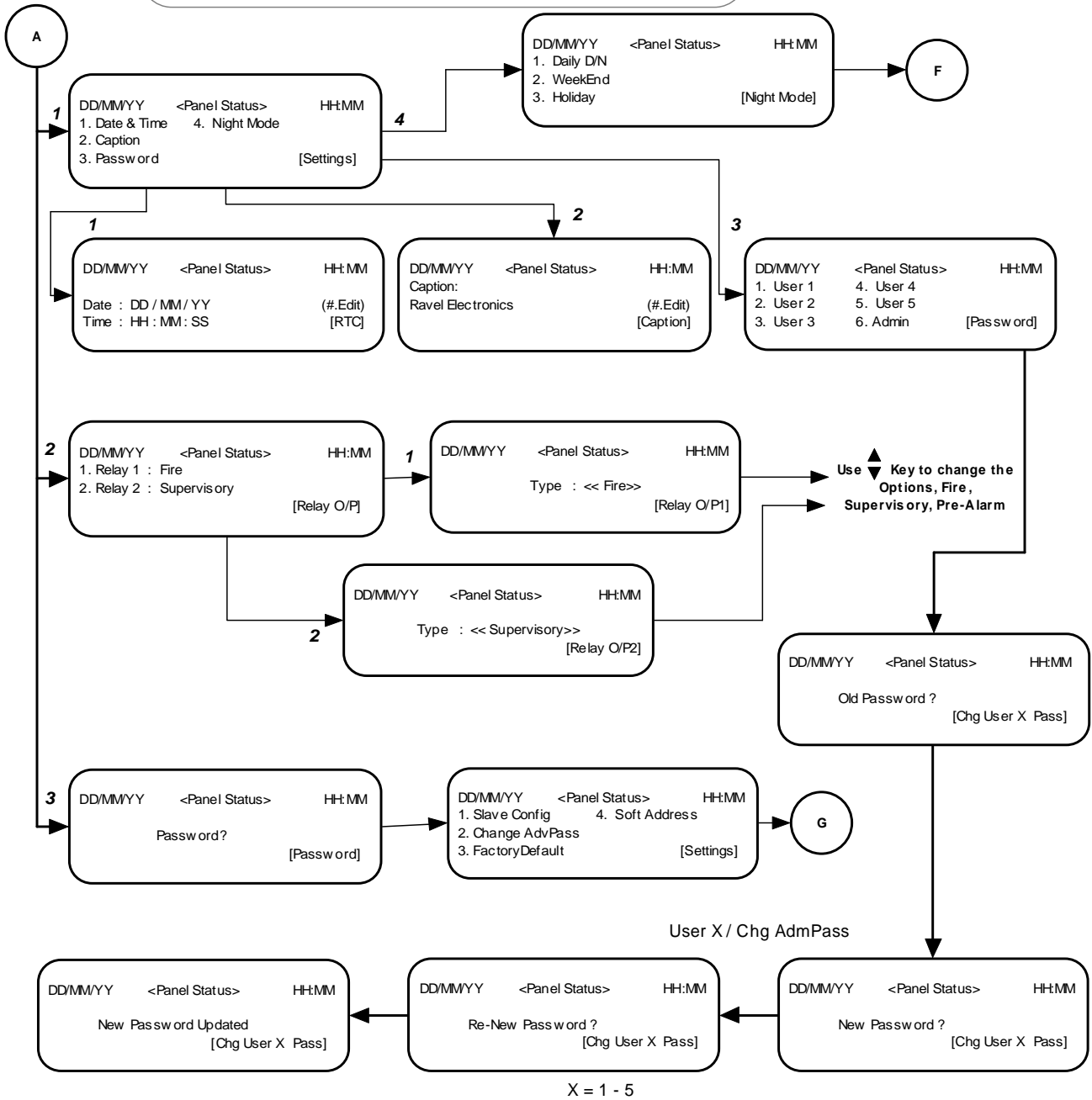

MENU KEY - FLOW DIAGRAM

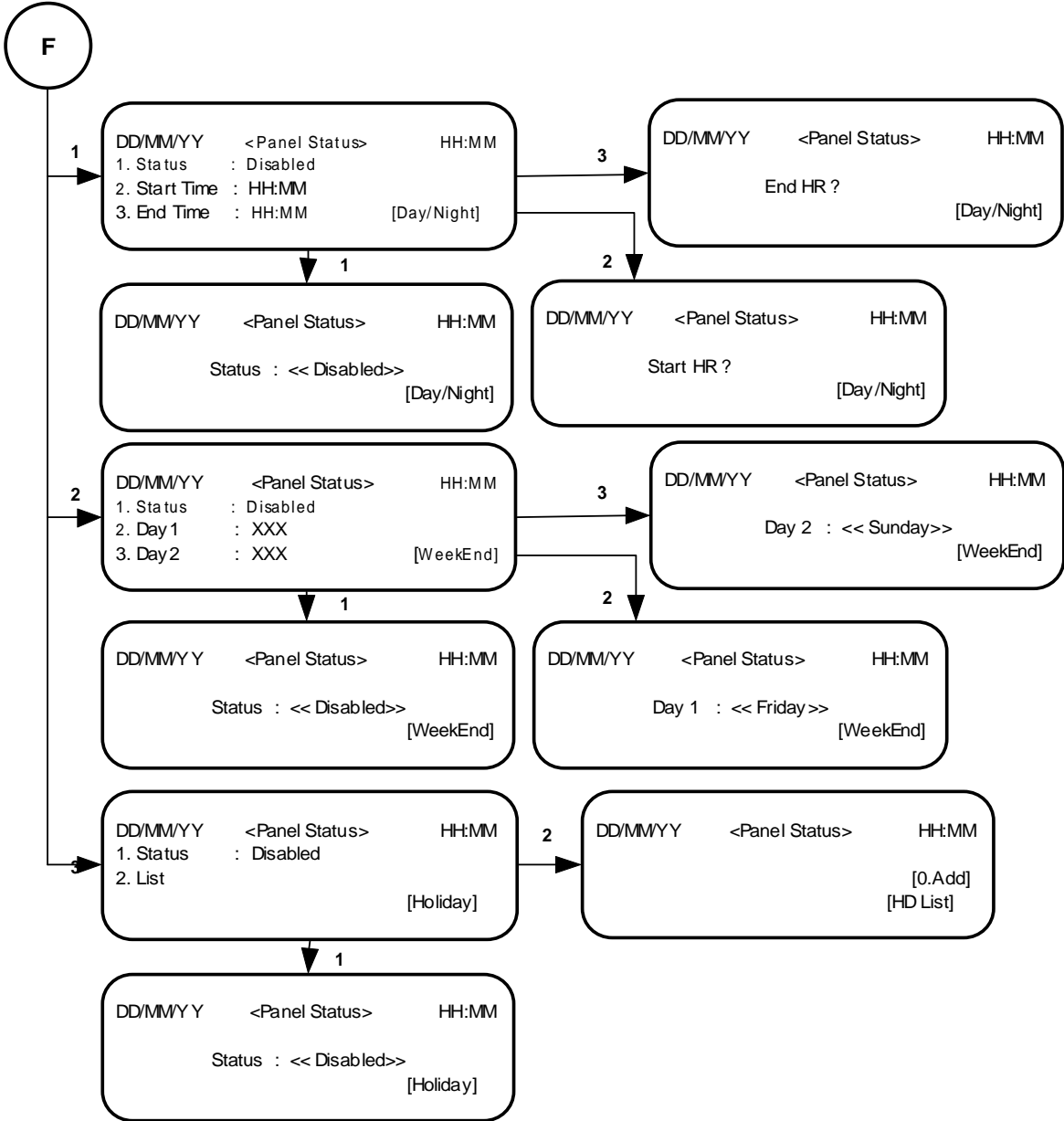

MENU KEY - FLOW DIAGRAM

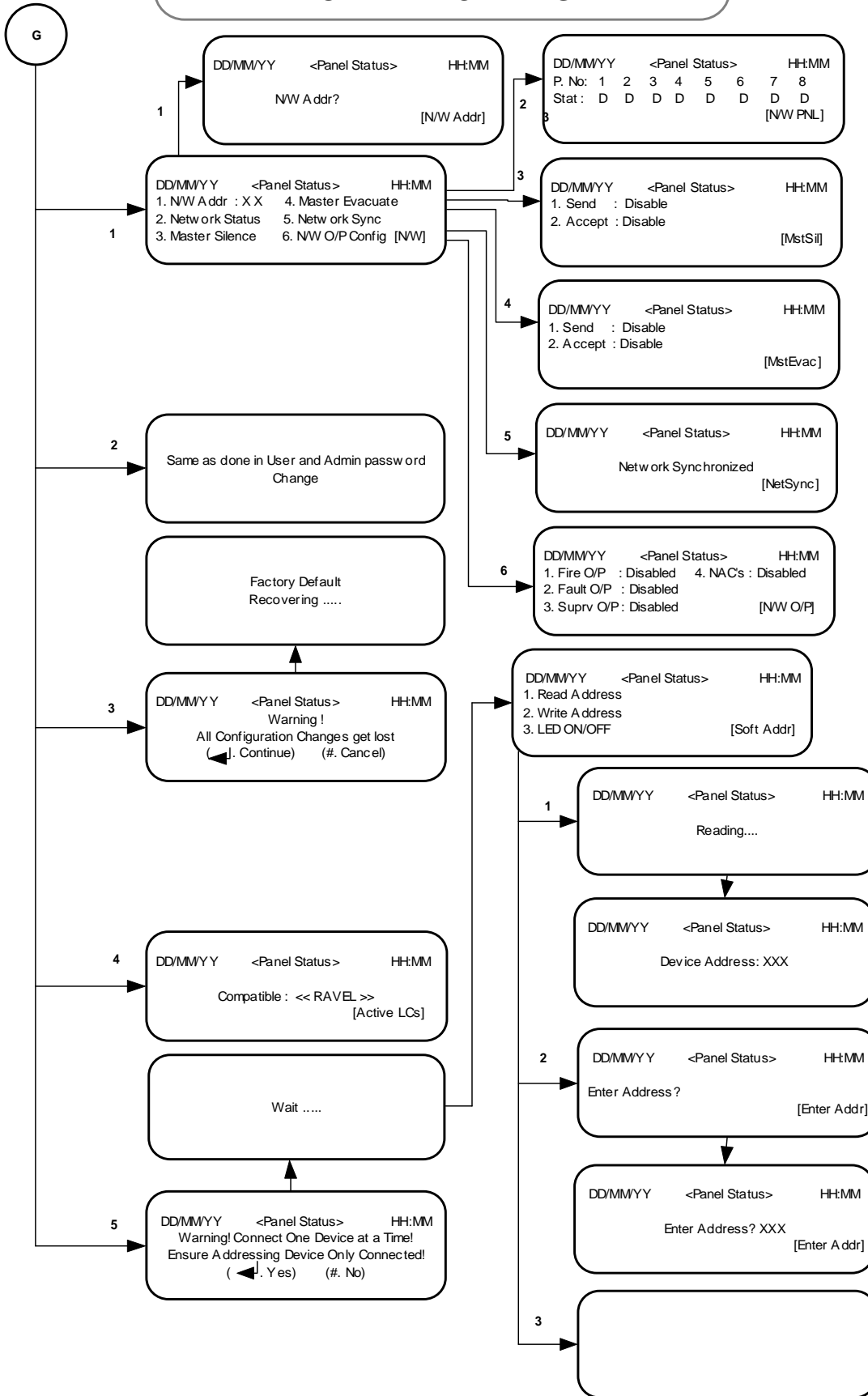

MENU KEY - FLOW DIAGRAM

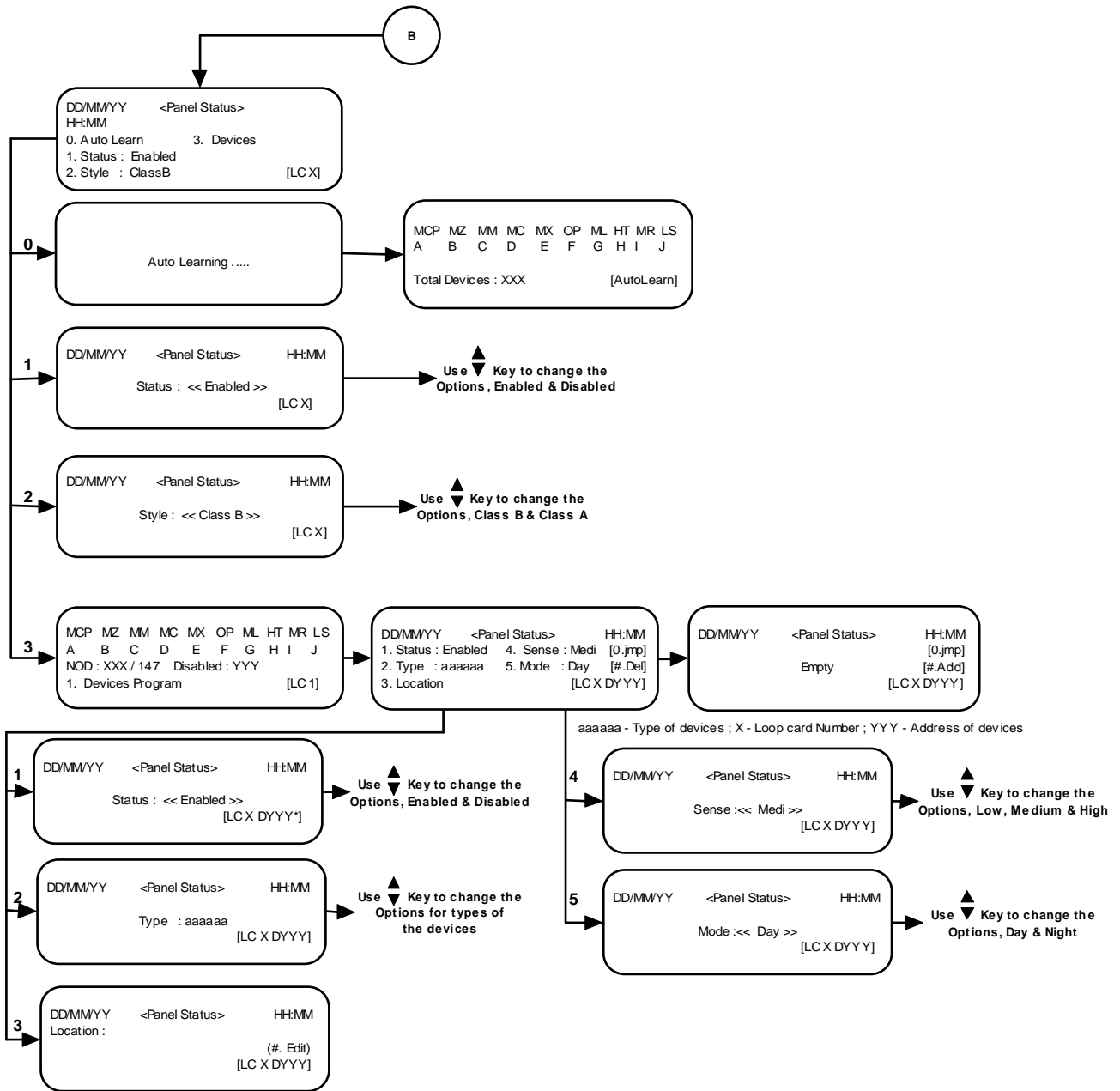

MENU KEY - FLOW DIAGRAM

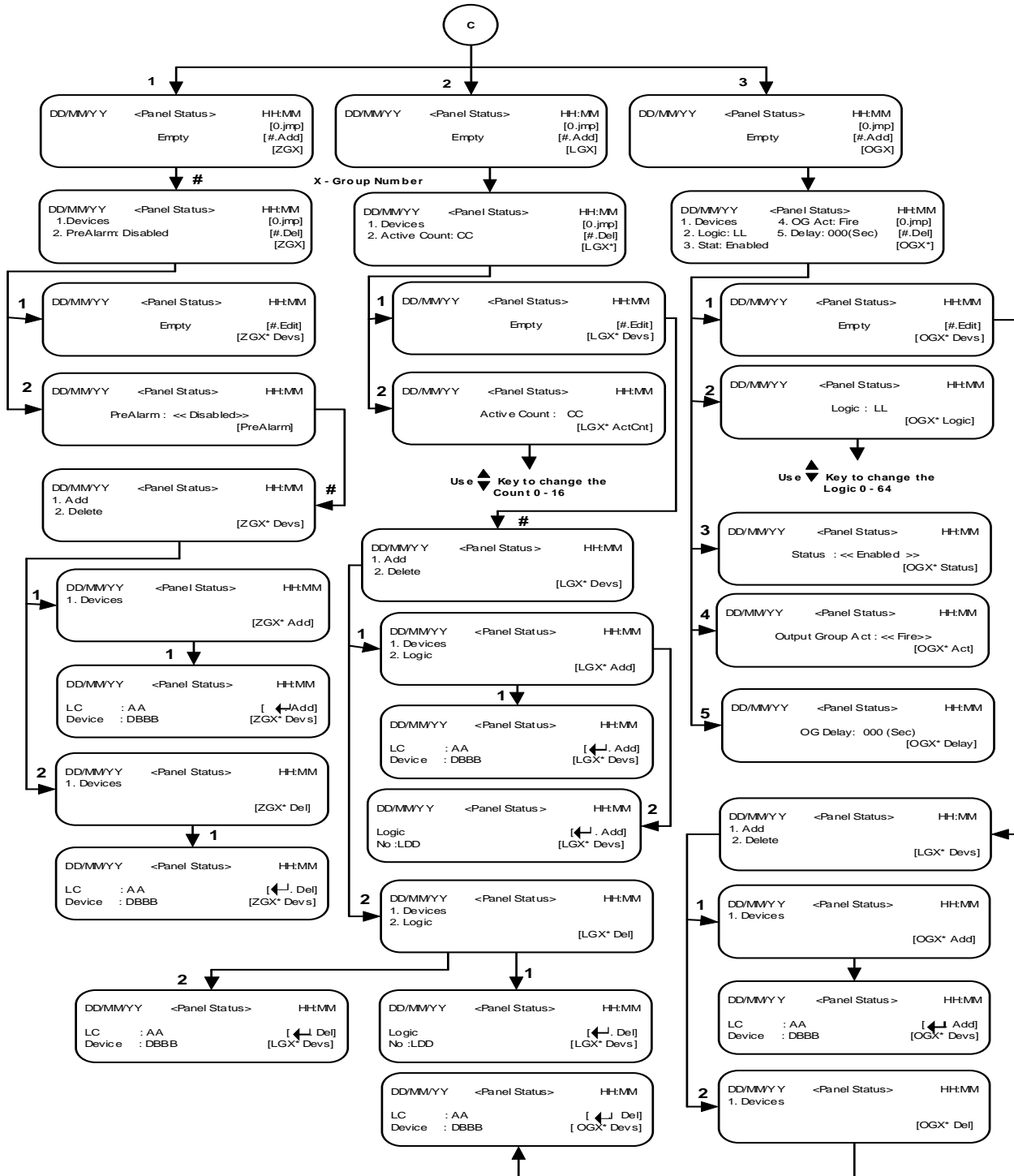

MENU KEY - FLOW DIAGRAM

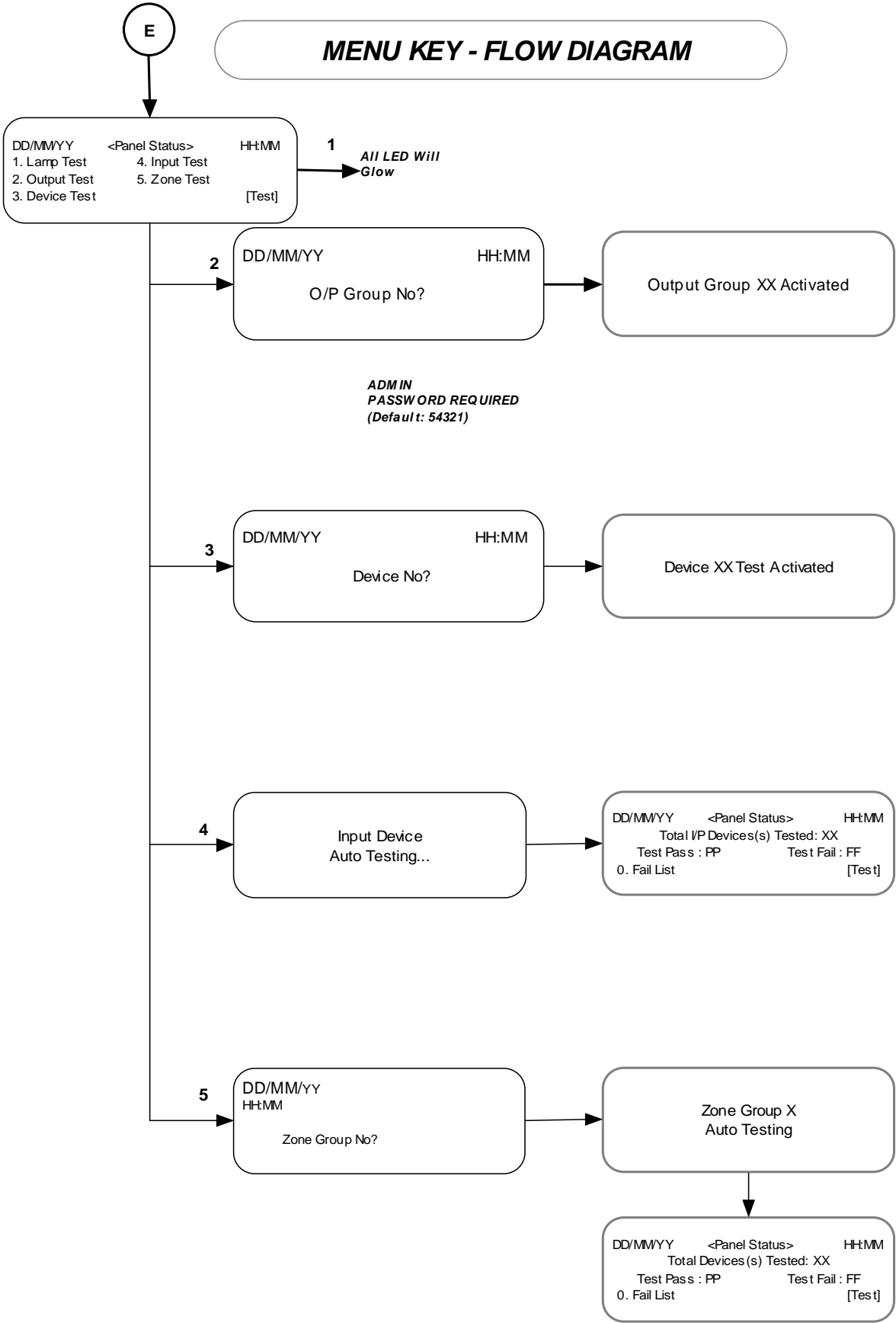

3.1.7 Main Menu

The MENU key navigates the user to view & Edit Loop Card specific settings, Device specific settings, etc. It also possesses help menu for About and Functional details. By Selecting Menu key the display shows the options as like below,

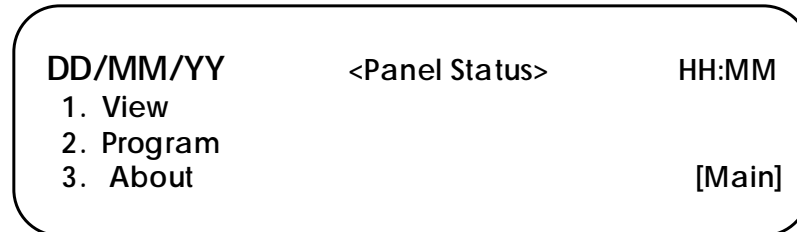

3.1.7.1 View

View Option can be accessible by User. By this option user can view the past history and exiting configuration, however they cannot change preserved settings. By selecting '1' when in Main menu, the system enters into View mode and shows the viewing category options as like below,

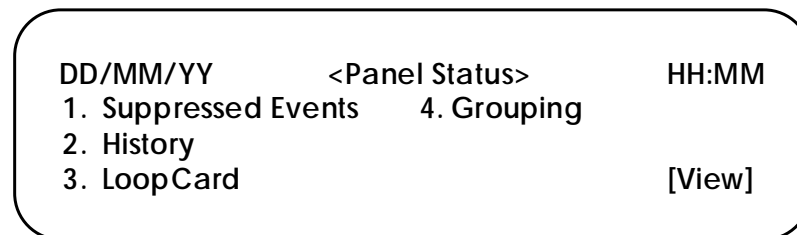

3.1.7.1.1 Suppressed Events

Suppressed Events option is used to view the suppressed events during Fire condition. The suppressed events like Prealarm, Supervisory and faults events can be viewed from this menu using corresponding number keys. By selecting '1' from view menu brings the suppressed events and shows the suppressed events category options as like below.

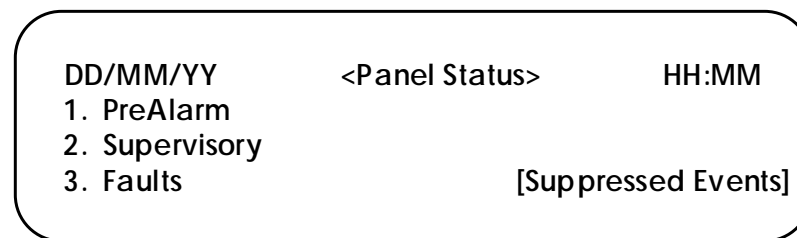

3.1.7.1.2 History

History option is used to view the past panel event logs such as Alarm, Supervisory, Fault, Silence Reset and etc., with Real Time Clock. By pressing the key '2' from View menu brings the History mode. The history mode provides the following event filtering option,

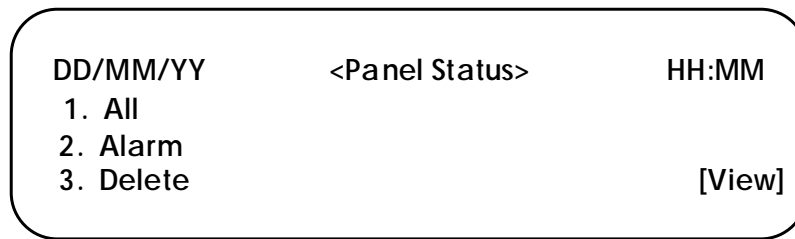

By selecting a number from the list in the history menu, respected subject relevant logs alone displayed in the screen as like below,

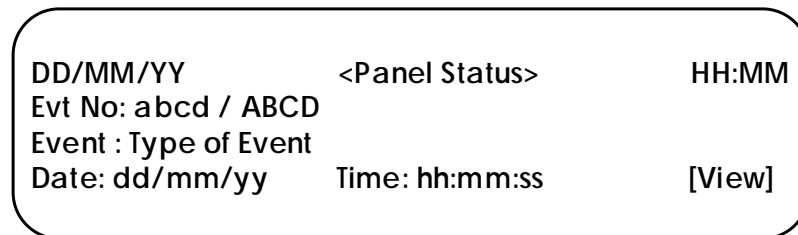

3.1.7.1.3 Loop Card

In order to view the loop card specific settings (such as wiring style, no. of devices, status) the user need to press '3' from the View Menu. The loop card details can be viewed by pressing corresponding loop card number and screen as shown below.

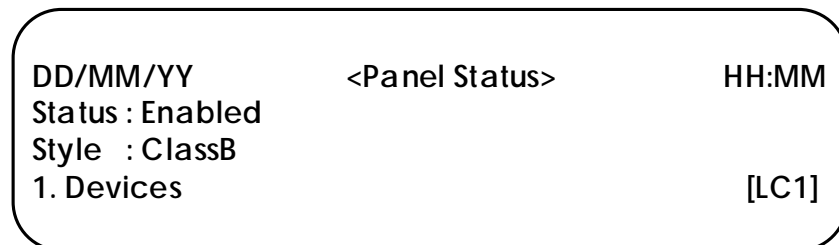

It also possesses the options to view Device Specific Settings. By selecting a number from the list in the Loop card menu, respected subject relevant configuration alone displayed in the screen as like below,

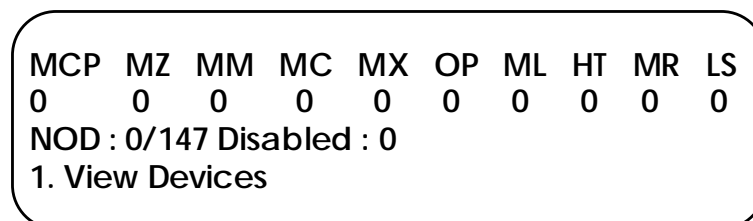

3.1.7.1.4 Grouping

By selecting number 4 from view menu, user can view the all types of grouping and grouped devices in each groups. The grouping menu screen is as shown below.

DD/MM/YY	Fault [XX]	HH:MM
1. Zone		
2. Logic Input		
3. Logic Output		[Grouping]

3.1.7.2 Program

By selecting the number 2 from the main menu screen, the system enters into program mode. This mode is protected by password and it requires admin password (Default – 54321). In this mode, the panel loop card configuration, RTC & password settings, to alter the optional features and to reset the panel for factory default setting. After entering into the view mode, screen will be as below.

DD/MM/YY	<Panel Status>	HH:MM
1. System	4. Features	
2. LoopCard		
3. Grouping		[program]

3.1.7.2.1 System

By selecting the number 1 from the program screen, the system enters into panel's configuration mode. In this mode, panel settings (RTC, Caption, Password), relay output configuration and advanced Feature configuration will be done. After entering into this mode, screen will be as below.

DD/MM/YY	<Panel Status>	HH:MM
1. Settings		
2. Relay O/P		
3. Advanced		[System]

3.1.7.2.1.1 Settings

By selecting the number 1 from the System screen, the system enters into panel settings mode. In this mode, Date & Time, caption, Password and night mode are changed by entering into the corresponding menu. After entering into this mode, screen will be as below.

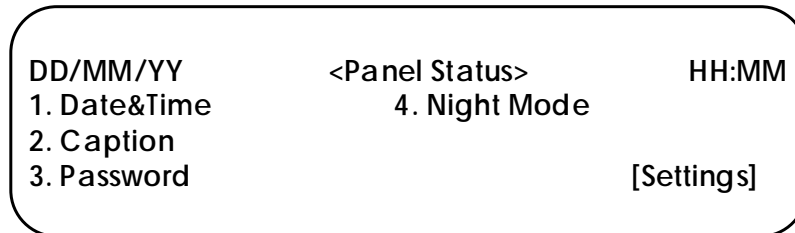

By selecting a number from the list in the system menu, respected subject relevant configuration alone displayed.

3.1.7.2.1.1.1 Date & Time

By selecting the number 1 from the setting screen, the system enters into RTC settings mode. In this mode, time and date settings are changed by using '#' key. After entering into this mode, screen will be as below.

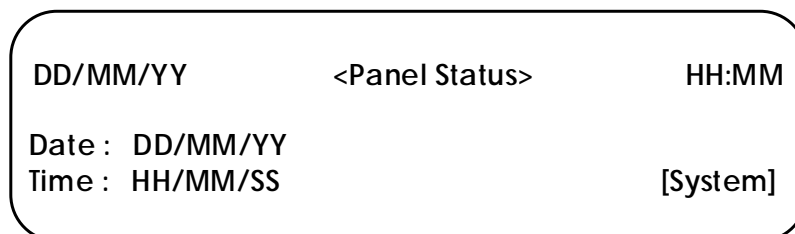

3.1.7.2.1.1.2 Caption

By selecting the number 2 from the setting screen, the system enters into Caption editing mode. In this mode, caption is changed by using '#' key, maximum 20 characters can entered which will be display in front screen in system healthy mode. After entering into this mode, screen will be as below.

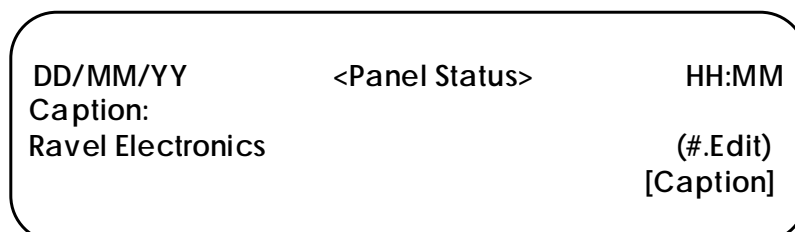

3.1.7.2.1.1.3 Password

By selecting the number 3 from the setting screen, the system enters into password change mode. In this mode, the user 1 to 5 and admin password can be changed by selecting corresponding number, after entering into this mode, screen will be as below.

DD/MM/YY	<Panel Status>	HH:MM
1. User 1	4. User 4	
2. User 2	5. User 5	
3. User 3	6. Admin	[Chg Pass]

After selecting corresponding number, password changing screen as follows:

DD/MM/YY	<Panel Status>	HH:MM
Old Password?		[Chg XXX Pass]



XXX – User 1/2/3/4/5/admin

DD/MM/YY	<Panel Status>	HH:MM
New Password?		[Chg XXX Pass]



DD/MM/YY	<Panel Status>	HH:MM
Re-New Password?		[Chg XXX Pass]



DD/MM/YY	<Panel Status>	HH:MM
New Password Updated		[Chg XXX Pass]

3.1.7.2.1.1.4 Night Mode

By selecting the number 4 from the setting screen, the system enters into night mode configuration. In this mode, the daily day/night time, week end day and holidays list can be configured, after entering into this mode, screen will be as below.

DD/MM/YY	<Panel Status>	HH:MM
1. Daily D/N		
2. WeekEnd		
3. Holiday		[NightMode]

3.1.7.2.1.1.4.1 Daily D/N

By selecting the number 1 from the night mode screen, the system enters into Daily Day /night time and status configuration mode. In this mode, the daily day/night time and status can be configured, after entering into this mode, screen will be as below.

DD/MM/YY	<Panel Status>	HH:MM
1. Status : Disabled		
2. Start Time : HH:MM		
3. End Time : HH:MM		[Day/Night]

The status can be changed by using appropriate number from keypad and by using up & down cursor keys. Similarly the day / night start and end time can be changed by selecting number 2 & 3 from the DayNight mode.

3.1.7.2.1.1.4.2 WeekEnd

By selecting the number 2 from the night mode screen, the system enters into week end day and status configuration mode. In this mode, the week end day and status can be configured, after entering into this mode, screen will be as below.

DD/MM/YY	<Panel Status>	HH:MM
1. Status : Disabled		
2. Day 1 : FRI		
3. Day 1 : SAT		[WeekEnd]

3.1.7.2.1.1.4.3 Holiday

By selecting the number 3 from the night mode screen, the system enters into Holiday list and status configuration mode. In this mode, the holiday list and status can be configured, after entering into this mode, screen will be as below.

DD/MM/YY	<Panel Status>	HH:MM
1. Status	: Disabled	
2. List		[Holiday]

Dates of holidays can be listed by selecting 2 from the Holiday screen. These lists can be enabled / disabled by selecting 1 from the holiday screen using up & down cursor keys.

3.1.7.2.1.2 Relay OP

By selecting the number '2' from the system screen, the system enters into the programmable relay output configuration mode. In this mode, by choosing corresponding number to the corresponding relay output can be configured as Fire, Supervisory and PreAlarm. After entering into this mode, screen will be as below.

DD/MM/YY	<Panel Status>	HH:MM
1. Relay 1 : Fire		
2. Relay 2 : Supervisory		[Relay OP]

By selecting corresponding number, the relay output options can be changed using the up & down '▲▼' cursor keys.

3.1.7.2.1.3 Advanced

By selecting the number '3' from the system screen, the system enters into advanced settings mode. It required the Configuration (Advanced) password. In this mode, the system up gradation like adding network Configuration for Repeater, changing the configuration password, factory resetting and Soft Addressing can be done. The default Configuration password is "654321". After entering into this mode, screen will be as below.

DD/MM/YY	<Panel Status>	HH:MM:SS
1. Network	4. Compatible : RAVEL	
2. Change AdvPass	5. Soft Address	
3. FactoryDefault		[Advanced]

3.1.7.2.1.3.1 Network:

By selecting the number 1 from the advanced menu screen, the system enters into the slave configuration mode. In this mode the slave address configuration and its status shall be viewed. After entering into this mode, screen will be as below.

DD/MM/YY	<Panel Status>	HH:MM:SS
1. N/W Addr : X X	4. Master Evacuate	
2. Network Status	5. Network Sync	
3. Master Silence	6. N/W O/P Config [N/W]	

3.1.7.2.1.3.2 Changing Advanced Password:

By selecting the number 2 from the advanced screen, the system enters into the advanced password change mode. The procedure for changing the password is similar to the user/admin password changing method. After entering into this mode, screen will be as below.

DD/MM/YY	<Panel Status>	HH:MM
Old Password ?		
		[ChgAdvPass]

3.1.7.2.1.3.3 Factory Default:

By selecting the number 3 from the advanced screen, the system enters into the factory default setting mode. In this mode, it gives the warning screen before changing configuration. After entering into this mode, screen will be as below.

DD/MM/YY	<Panel Status>	HH:MM
Warning!		
All Configuration Changes get lost		
(←). Continue) (#. Cancel)		

3.1.7.2.1.3.4 **Soft Addressing:**

By selecting the number 4 from the advanced menu / screen, the system enters into the device soft addressing mode. From this menu address of the initiating devices & output devices shall be programmed. Only one device has to connect with the SLC loop for addressing that device and after address written on the device, device ID will be automatically incremented to next address. From this menu you can read / write the address of the connected device and LED on/off control shall be done. After entering into this menu, screen will be as below.

DD/MM/YY	<Panel Status>	HH:MM
1. Read Address		
2. Write Address		
3. LED ON/OFF		[Soft Addr]

3.1.7.2.2 **Loop Card**

By selecting the number 2 from the program screen, the system enters into loop card settings mode. After entering into this mode, screen will be as below.

DD/MM/YY	<Panel Status>	HH:MM
0. AutoLearn	3. Devices	
1. Status : Enabled		
2. Style : ClassB		[LC]

To view and change loop card configurations can be configured from this menu. Auto Learning, configuration like style, enabled/disabled and devices is done. Also the devices can be added manually through the devices menu.

From this menu, required field is configured by pressing corresponding number from the key pad.

3.1.7.2.2.1 Auto Learn

Auto Learning is done pressing the key '0' from the selected loop card screen. Auto learn is used to learn type of all the devices connected in the loop card and gives the details about devices and total number of devices connected in the loop card.

Ravel Protocol - After scanning the LCD Screen shown as below.

```
MCP MZ MM MC MX OP ML HT MR LS
A   B  C  D  E  F  G  H  I  J
NOD : XXX / 147 Disabled : YYY
1. Devices Program [LC 1]
```

Where XXX – Total number of device;
YYY – Total number of disabled devices;
A – Total number of Manual Call Point;
B – Total number of Zone module;
C – Total number of Switch monitor module
D – Total number of Control Module;
E – Total number of Input-Output Module;
F – Total number of Optical Detectors;
G – Total number of Multipoint Detectors;
H – Total number of Heat Detectors;
I – Total number of Relay Module;
J – Total number of Loop powered Sounder;

3.1.7.2.2.2 Status

The status is nothing but the loop card disabled / enabled. The status of the loop card is change is done by selecting the number '1' from the loop card menu list. After entering into the change mode, up & down cursor key is used to change the options and press the enter key to accept the changes. The 'n' represents nth loop card.

```
DD/MM/YY          <Panel Status>          HH:MM
                  Status : << Enabled >>
                                      [LC'n']
```

3.1.7.2.2.3 Style

By selecting the number 2 from the loop card screen, the system enters into loop card style configuration mode. Type of

style Class A or Class B can select by using the up & down cursor keys. After selecting the required style press 'enter' key to conform the selection.

DD/MM/YY	<Panel Status>	HH:MM
	Style : << ClassB >>	[LC'n']

3.1.7.2.2.4 Device

By selecting the number 3 from the loop card screen, the system shows the number of detectors and modules are connected in the system. Also from this menu detector and module programming can done by pressing corresponding number.

Ravel Screen:

MCP	MZ	MM	MC	MX	OP	ML	HT	MR	LS
A	B	C	D	E	F	G	H	I	J
NOD : XXX / 147					Disabled : YYY				
1. Devices Program								[LC 1]	

3.1.7.2.2.4.1 Detector Program

From this menu, if the auto learning is not done then, the individual detectors status, type, sense, mode and location can be configured manually by selecting the corresponding number from the numerical keypad. Detector address is shown at right bottom of the screen and detector address is selected by using the left/Right cursor keys. The options are changed by using the up/down cursor keys.

DD/MM/YY	<Panel Status>	HH:MM
1. Status : Enabled	4. Sense : Low	
2. Type : Optical	5. Mode : Day	[#. Del]
3. Locations		[LC1 D001*]

Options are:

1. Status : Enabled / Disabled
2. Type : Optical / Multi / Heat
3. Location – Detector Location
4. Sense : Low / Medium / High (Detector Sensitivity)

5. Mode : Day / Night

3.1.7.2.2.4.2 Module Program

From this menu, if the auto learning is not done then, the individual modules status, type, category and location can be configured manually by selecting the corresponding number from the numerical keypad. Module address with loop card number is shown at right bottom of the screen and module address is selected by using the left/Right cursor keys. The options are changed by using the up/down cursor keys.

DD/MM/YY	<Panel Status>	HH:MM
1. Status : Enabled	4. IP : Alrm	[#. Del]
2. Type : MM		[LC1 M001*]
3. Location		

Options are:

1. Status : Enabled / Disabled
2. Type : IP_M / OP_M / IO_M
3. Location – Module Location
4. IP: Alarm / Supervisory
5. Cat : Control / Relay / Others (Module Category)
6. DeAct: Rst (Reset) / Sil (Silence). (Selection for Deactivation of the device during silence / reset)

3.1.7.2.3 Grouping

By selecting the number 3 from the program screen, the system enters into Group Setting mode. This mode is used to combine the number of devices as a zone / Logic / Output group. After entering into this mode, screen will be as below.

DD/MM/YY	<Panel Status>	HH:MM:SS
1. Zone		
2. Logic Input		
3. Logic Output		[Grouping]

Zone Grouping

By selecting the number 1 from the grouping screen, the system enters into the zone grouping mode. In this grouping maximum 64 zone can group with maximum 16 devices can add in each zone group. After entering into this mode, screen will be as below.

DD/MM/YY	<Panel Status>	HH:MM
	Empty	[#.Add] [ZG1]

After adding the zone group screen shows as below and device can added by selecting number 1 from Zone group 1 screen.

DD/MM/YY	<Panel Status>	HH:MM
1. Devices		[0.Jmp]
2. PreAlarm : Disabled		[#.Del] [ZG1]

In zone grouping the pre-alarm is enabled. Then first detector is sensed fire, panel will not trigger NAC's and on second detector is sensed fire then panel will trigger the NAC's and shows as alarm.

Logic Input Grouping

By selecting the number 2 from the grouping screen, the system enters into the logic grouping mode. This mode is used to give the output to the output device through the output grouping. After entering into this mode, screen will be as below.

DD/MM/YY	<Panel Status>	HH:MM
	Empty	[0. Jmp] [#.Add] [LG1]

After adding the logic group, screen shows as. Devices shall be added using the sub menu '1'. Depending upon the active counter the logic gives the output.

DD/MM/YY	<Panel Status>	HH:MM
1. Devices		[0. Jmp]
2. Active Count: 1		[#.Del]
		[LG1]

For example, the 10 devices are added in the devices and logic count is entered as '4', then 4 out of 10 devices gets fire then only the logic gives the output.

DD/MM/YY	<Panel Status>	HH:MM
	Empty	[#.Edit]
		[LG1* Devs]

By Pressing '#' key it enters into add / delete menu. In device sub menu, the adding devices and deleting devices shall be done. Device shall add using the sub menu '1' and delete by '2'. After entering into the add/ delete menu devices will be shown in last line by pressing 'Enter' key, the devices shall be add/delete.

DD/MM/YY	<Panel Status>	HH:MM
1. Add		
2. Delete		[#.Del]
		[LG1 Devs]

If there is no devices in the loop, it shows in display as "No More I/P Device" otherwise as shown below.

DD/MM/YY	<Panel Status>	HH:MM
LC : NN		[0. Mdle]
Devices : DXX		[←.Add]
		[LG1* Devs]

NN – Loop card number; DXX – Detector address; MXX – Module Address. Similarly for deleting the devices.

Logic Output Grouping

By selecting the number 3 from the grouping screen, the system enters into the output grouping mode. This mode is used to turn on the output devices with respect to the logic. After entering into this mode, screen will be as below.

DD/MM/YY	<Panel Status>	HH:MM
	Empty	[0. Jmp] [#.Add] [OG1]

After adding the output group, screen shows as below. Devices shall be added using the sub menu '1'. Depending upon the Logic number the output devices which are all grouped gets on.

For example, the 10 devices are added in the devices and Logic is entered as '4', then the devices added in the group will turn on for the logic 4 only.

DD/MM/YY	<Panel Status>	HH:MM
1. Devices 2. Logic: 0		[0. Jmp] [#.Del] [OG1*]

By pressing the '1' the screen shown as below.

DD/MM/YY	<Panel Status>	HH:MM
	Empty	[#.Edit] [OG1* Devs]

By Pressing '#' key it enters into the add / delete menu. In device sub menu, the adding devices and deleting devices shall be done. Device shall add using the sub menu '1' and delete by '2'. After entering into the add/ delete menu devices will be shown in last line by pressing 'Enter' key, the devices shall be add/delete.

DD/MM/YY	<Panel Status>	HH:MM
1. Add 2. Delete		[#.Del] [OG1 Devs]

If there is no devices in the loop, it shows in display as "No More O/P Device" otherwise as shown below.

AC Loss Delay:

When AC power is lost, the control panel trouble relay will activate. The factory default option for this feature is Enabled, the trouble relay activation on AC loss after the time delay setting. Relay activation may be delayed by selected as shown in LCD screen display. Press up & down keys to toggle between enabled / disabled option. The AC Loss Delay timing can set 001 to 999min. After setting the required time press Enter key to accept the time. When you enter into this mode the screen will be as below.

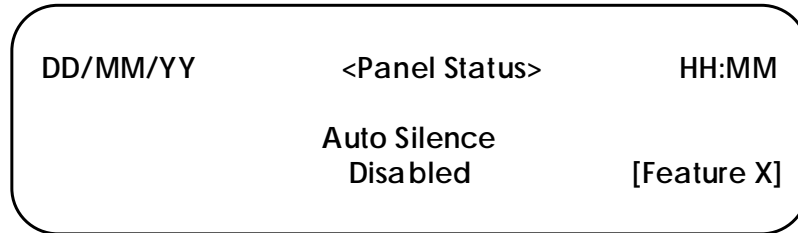

Trouble Reminder:

The Trouble Reminder feature provides an audible reminder that a fire/supervisory/Fault still exists on the panel after the control panel has been silenced. The factory default for this feature is 'Enabled'. When this feature is 'enabled', the control panel buzzer will give a beep tone for every set time during a trouble condition, after the Signal Acknowledge switch is pressed. The buzzer tone will continue to sound at these rates until the trouble condition is cleared. Press up & down keys to toggle between enabled / disabled option. The Trouble Reminder timing can set 1 to 999mins. After setting the required time press Enter key to accept the time. When you enter into this mode the screen will be as below.

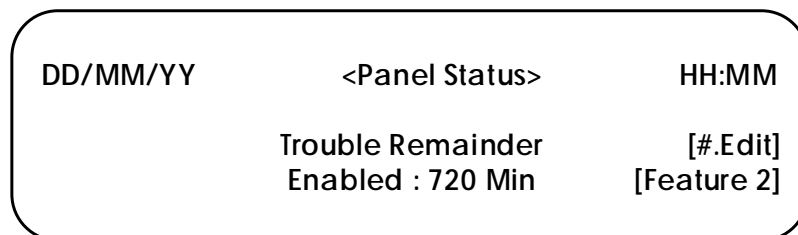

Auto Silence:

Auto-silence is the program feature that will automatically silence the Notification Appliance Circuits, if they are programmed as silenceable circuits, after a programmed time interval. The factory default setting is auto-silence disabled. Press up & down key to toggle between enabled / disabled option.

The Auto silence timing can be set from 001 to 999 seconds. After setting the required time press Enter key to accept the time. When you enter into this mode the screen will be as below.

DD/MM/YY	<Panel Status>	HH:MM
	Auto Silence Enabled : 120 Sec	[#.Edit] [Feature 3]

Silence Inhibit:

The Silence Inhibit feature prevents the silencing of Notification Appliance Circuits, using the Silence switch or Reset switch, for the amount of time corresponding to the selected option, after the NAC's are activated. The factory default for this feature is 'disabled'. Press up & down key to toggle between enabled / disabled option. The Silence inhibit timing can set 1 to 999 seconds. After setting the required time press Enter key to accept the time. When you enter into this mode the screen will be as below.

DD/MM/YY	<Panel Status>	HH:MM
	Silence Inhibit Enabled : 060 Sec	[#.Edit] [Feature 4]

Earth Fault Detection:

The Earth Fault Detection feature prevents the earth fault sense of all the field terminals, using this option user can enable or disable the earth fault detection. The factory default for this feature is 'disabled'. Press up & down key to toggle between enabled / disabled option. When you enter into this mode the screen will be as below.

DD/MM/YY	<Panel Status>	HH:MM
	Earth Fault Detection Disabled	[#.Edit] [Feature 5]

3.1.7.3 About

It shows the details of the panel by pressing number 3 from the menu screen. The LCD will show as below. In this screen the model and software version has shown.

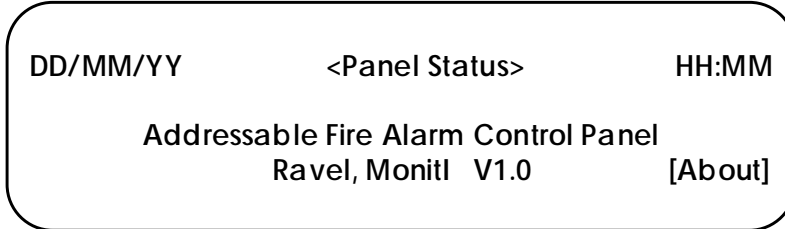

3.1.7.4 Test

By using the Test key from the keypad, the system entered into device testing mode connected in the loop cards and lamp test mode. After entering into this mode, the screen shows as below.

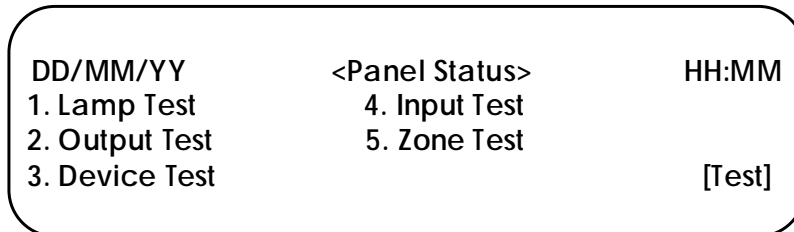

By pressing the '1' from this menu, the lamp test function would be activated to glow all the LED in the panel for 3 seconds.

By selecting the '2' from this menu, it enter into output test mode, system requires the admin password ("Default - 54321"). After entering into this mode, by giving the output group number that particular output grouped devices are activated for 3 seconds and then deactivated.

By selecting the '3' from this menu, it enters into the device test mode, system requires the admin password ("Default - 54321"). After entering into this mode, by giving the device number that particular device is activated for 3 seconds and then deactivated.

By selecting the '4' from this menu, it enters into the Input test mode, system requires the admin password ("Default - 54321"). After entering into this mode, It will test for all the input devices connected in the loop automatically and gives result in a separate screen.

By selecting the '5' from this menu, it enters into the zone group test mode, system requires the admin password ("Default - 54321"). After entering into this mode, by giving the zone group number that particular zone grouped devices are activated for 3 seconds and then deactivated.

Chapter 4 Operating Instruction

4.1 Panel Operation

The operation of the panel is described in this manual. In this manual the following details are described in detail, like inputs / outputs, indications, control keys, alarm, fault supervisory conditions etc.,

4.2 Initial Power up Condition

When the power is applied to the panel, the LCD will first display "System Initializing" and the panel will not respond to any key presses or to zone activity. Once this step is done the panel will shows "System Healthy" in LCD display and System On, Mains On and Battery On LED will glow.

4.3 SLC Loop Inputs

This type of input is the normal inputs to the system from smoke detectors, heat detectors, Manual Call points, modules etc. They are required to activate the NAC's like bell and or strobes as well as an LED. They can operate the relays and control modules in the network. It display as "ALARM" in the LCD and stores the events in Alarm list.

4.4 Indications

SYSTEM ON: This LED will glow when the panel is energized by primary and standby power. This is the only LED glowing in the normal monitoring condition. The LCD Display as shown below.

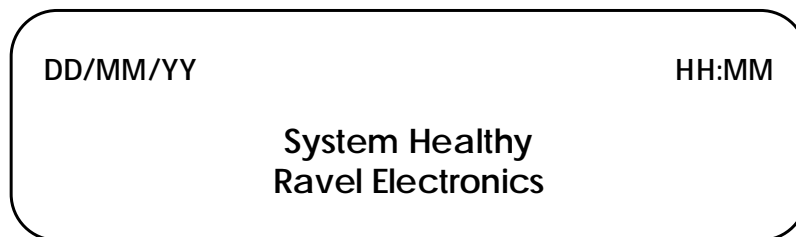

MAINS ON: It indicates that panel is operated through the mains supply (120 / 220VAC). Whenever the Main Supply (220v A.C) fails, the Mains ON LED will goes to off condition and it also indicated in LCD with toggle Buzzer tone.

BATTERY ON: It indicates that the battery is connected with the panels and it under charging. Whenever the backup battery fails, the battery ON LED will goes to off condition and it also indicated in LCD with toggle Buzzer tone. Similarly the same LED will blink when the battery voltage goes down below the 21.6v (Battery Low).

CHARGER FAULT: It indicates that the battery is connected with the panels and but the charger circuit is fail / battery is deep discharged. Whenever the backup battery

charger fails, the charger fault LED will be illuminated and it also indicated in LCD with toggle Buzzer tone.

EARTH(Ground) FAULT: Whenever the Signaling Device circuits (SLCs), Notification Alarm Circuits (NACs), Remote Inputs and DC output are gets contact with the Earth or Body of the cabinet, the earth fault LED and common fault LED will be illuminated and it also indicated in LCD earth fault with toggle Buzzer tone. The Earth fault can be created through 0 Ohms resistor.

SYSTEM FAULT: Glowing of this LED indicates the failure of the CPU.

SILENCED: This LED will glow when the silence key is pressed in fire condition only.

NAC FAULT: Whenever there is any fault in Notification Appliances Circuits like NAC loop Open / Short / Earth fault, it will be identified by COMMON NAC FAULT LED.

TEST: The test LED will glow whenever the Devices are under test mode.

FIRE: This twin fire LED will glow when any one or more of the devices are in fire condition.

SUPERVISORY: This supervisory LED will glow when any one or more of the zones are in supervisory condition.

FAULT: This fault LED will glow when any one or more of the zones are in fault condition.

ZONE FIRE: This fire LED will glow when the zones are fire condition. The first fired zone continuously in blink and other zone fire LED will glow steadily in fire condition. The fired zone is displayed in the LCD, first fire zone and total no. of zone is displayed separately.

DISABLE: This disable LED glows steadily in any input / output is in disabled condition.

NIGHT MODE: This day/night LED glows, panels is in night mode

PRE ALARM: This pre alarm LED glows when the first zone grouped (PreAlarm is enabled) device goes to alarm.

4.5 Buzzer

A piezo buzzer provides separate and distinct sounds for alarm, trouble and supervisory conditions:

- Alarm – Continuous
- Fault – pulse 0.5sec ON and 5sec OFF
- Supervisory – pulse 0.25sec ON and 0.25sec OFF

4.6 Operating Keys

The control keys are located at center of the front sticker and these keys are touch pad. They are as follows:

SILENCE Key: When the silence key is pressed, after entering the user or admin password the following will occur:

- The silenceable Notification Appliance Circuits will be turned OFF
- The Silence LED will be turned ON

Upon the occurrence of a subsequent fire event, Signal Silence is overridden and the control panel will respond to the new event.

RESET Key: When the Reset key is pressed, after entering user or admin password, the control panel will show the menu as below.

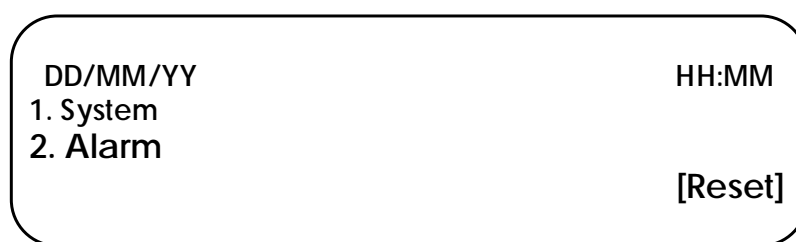

From the above menu entire system can reset or only alarm can reset by selecting appropriate number. By selecting number '2' from this menu, the system enters into reset the alarm from loop card or remote input. When you enter into this mode the screen will be as below.



To reset the only loop card, select '1' from this menu and enter the particular loop card number then press 'enter' key. Similarly to reset the remote input, select '2' from this menu and enter the particular input number then press 'enter' key. Then the following actions will done.

- Clear the status LED's.
- Bring back the LCD display to the healthy condition.
- Turn off the Notification Appliance Circuits.
- Reset fire zones by temporarily removing power.
- Restore all system relays to normal.

The Reset key is accessible only after silencing in alarm condition.

Any alarm, supervisory or trouble condition that exists after a system reset, will resound the system, reactivating normal system activity.

ACK. Key: This key is used to acknowledge the buzzer tone during the fault and fire condition. This key can be operated with user or admin password.

EVACUATE Key: This key is used to energize the all-external NAC's without actual fire, It will operate at user or admin level. Using the silence key NAC output can be silenced.

ENTER KEY: This key is used to accept the password during silence, reset in Fire Condition And also used for the Evacuate and wherever requires.

CURSOR KEYS: The cursor keys (Right / Left arrows) are used to move the cursor point wherever required.

ALPHANUMERIC KEYS: These keys are used for entering the names etc. and numbers. '*' Key is used to go back the previous screen in programming mode.

MENU KEYS: The menu key is used to get into the program menu to change the required configurations. It requires password to change the configurations.

TEST KEYS: The help key is used to test the lamps and SLC devices in individual loops.

4.7 Normal Monitoring Mode

Normal Mode is the standard mode of operation. In this mode, the panel continuously monitors system status. When no fire or supervisory or trouble conditions exist, all LEDs will be off except the System On, Mains On and Battery On LED. The Notification Appliance Circuits will be off, all relays are in their normal state and the onboard buzzer will be off. When the system is in normal condition the LCD screen will be as "System Healthy".

4.8 Alarm Condition

When the control panel detects Fire via the Detector / MCP, the panel will cause the following:

- ✓ The common twin Fire LEDs will glow.
- ✓ Turn on the NAC's.
- ✓ Turn on the panel buzzer with continuous tone.
- ✓ Turn on the fire relay.

In case of multiple zone fire, the origin zone fire LED will be blinking and subsequent zone fire LED will glow steadily.

To change the other indexed fire event zones which are suppressed use right / left arrow keys.

Restoral: Silence the NAC's by appropriate user or admin password. after silencing the panel will perform the following;

- Turn off the Internal Buzzer.
- Turn off the External NAC's.
- Turn on the silenced LED.

When the Fire condition is cleared and Reset key has been pressed after entering the user or admin password. The Reset is accessed only after silencing the panel in alarm condition. The panel will perform the following after clearing fire and resetting:

- Turn off the common twin Fire LEDs.
- Turn off the Fire relay.

The LCD screen will be as below.

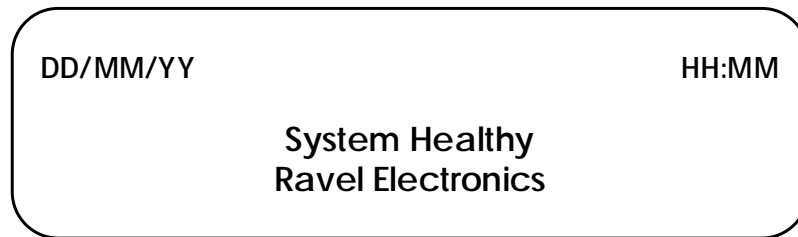

4.9 Supervisory Condition

When the control panel detects supervisory signal via the any normally open contact devices, the panel will cause the following:

- ✓ The common supervisory LED will glow.
- ✓ Turn on the panel buzzer with intermittent buzzer tone (pulse 0.25sec ON and 0.25sec OFF).
- ✓ Turn on the supervisory relay.

In case of multiple zone supervisory, the origin zone and recent zone supervisory LED will be viewed in LCD screen.

To change the other indexed supervisory event zones which are suppressed use right / left arrow keys.

Restoral: When the supervisory condition is cleared and Reset key has been pressed after entering the user or admin password if the zones are programmed for latching, the panel will perform the following:

- Turn off the supervisory LEDs.
- Turn off the supervisory relay.

The LCD screen will be as below.

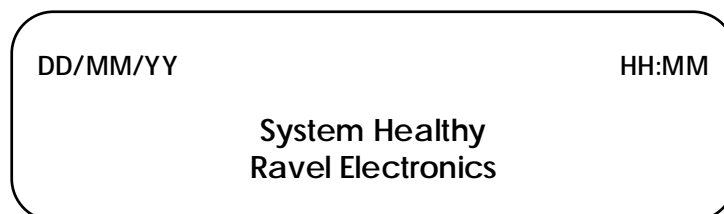

Note:

If the supervisory mode is selected as resettable, the resetting the zone is not required. The zone is retrieved automatically after clearing the supervisory condition.

4.10 Fault Condition

The fault may any one of the following Zone fault / disable / earth fault, NAC fault and power section fault. When there is one or more fault condition, the fire alarm control panel performs the following:

- Turn on the common fault LED.
- Turn on the NAC fault / power fault LED.
- Turn on the panel buzzer tone with intermittent buzzer tone (pulse 0.5sec ON and 5sec OFF).
- Activate the fault relay.

Restoral: When the fault condition is cleared, the panel will perform the following automatically:

- Turn off the fault LEDs.
- Turn off the NAC fault / power fault LED.
- Turns off the buzzer tone.
- Deactivate the fault relay.

The LCD screen will be as below.

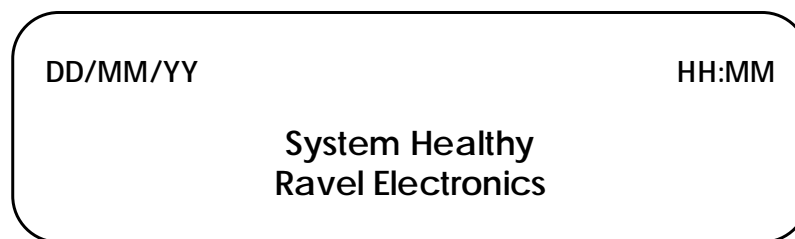

Note: The Fault occurred will not affect the other normal functions of the panel

4.11 Test Condition

The panel LED's and devices connected with the panel can be tested through the menu from the Test key. By pressing the 'Test key', the system enters into the test mode and in this there are three test modes like lamp test, Output Test and Device test. After entering into this mode, the LCD screen will as shown below.

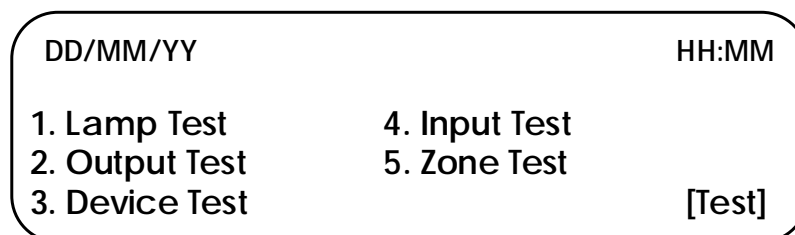

4.11.1 Lamp Test

By entering into this menu using the number '1' key, the LED in the panel will turn on. The LED status shall be checked by using this menu.

4.11.2 Output Test

By pressing the number '2' from the key pad, the system enters into the output test mode. The devices connected in the output group can be tested by group wise selecting corresponding number. Test LED is illuminates continuously identifies the SLC/System, which is under test. The device turns on for 3 seconds and turns off automatically. During test mode, the NAC outputs will not be activated.

4.11.3 Device Test

By pressing the number '3' from the key pad, the system enters into the Device test mode. The devices connected in the SLC loop can be tested by loop card wise for each device by selecting corresponding number. Test LED is illuminates continuously identifies the SLC/System, which is under test. The device turns on for 3 seconds and turns off automatically. During test mode, the NAC outputs will not be activated.

4.12 Disable Condition

Disable: The any device/loop card can be Disabled / Enabled through the programming. The ON status of disabled LED and common fault LED indicates, the Device/loop card is disabled and the OFF status of the LED indicates the enabled.

Chapter 5: Servicing:

5.1 Installation/Replacement of PCB:

Remove the screws of PCB, which has to be change and remove the PCB from the mounting position and place the new PCB in that same position as shown below.

Mounting position for Main Circuit board (RAVEL RE - ADR – MB):

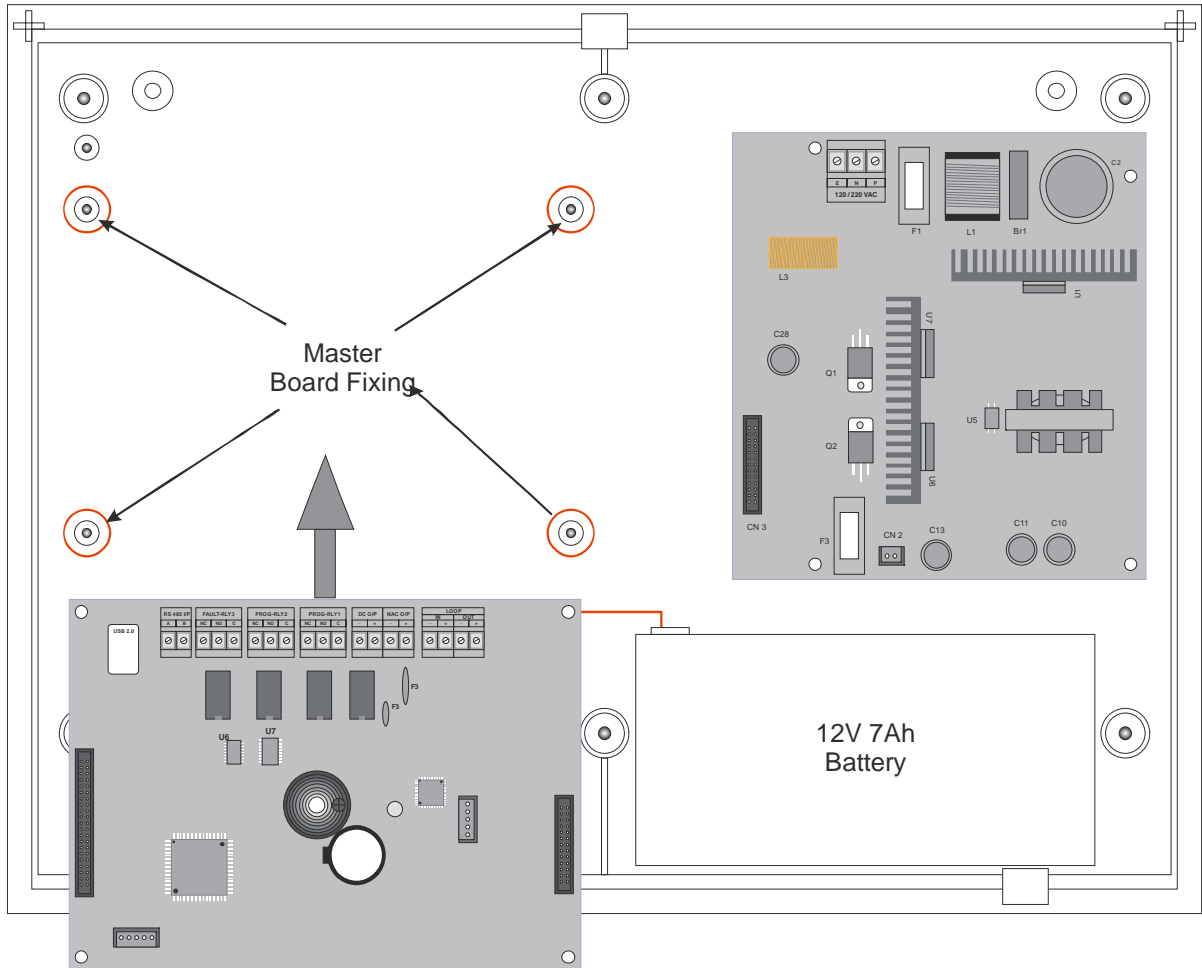

Figure – 18

Mounting position for Display board (RAVEL RE – ADR –DISP):

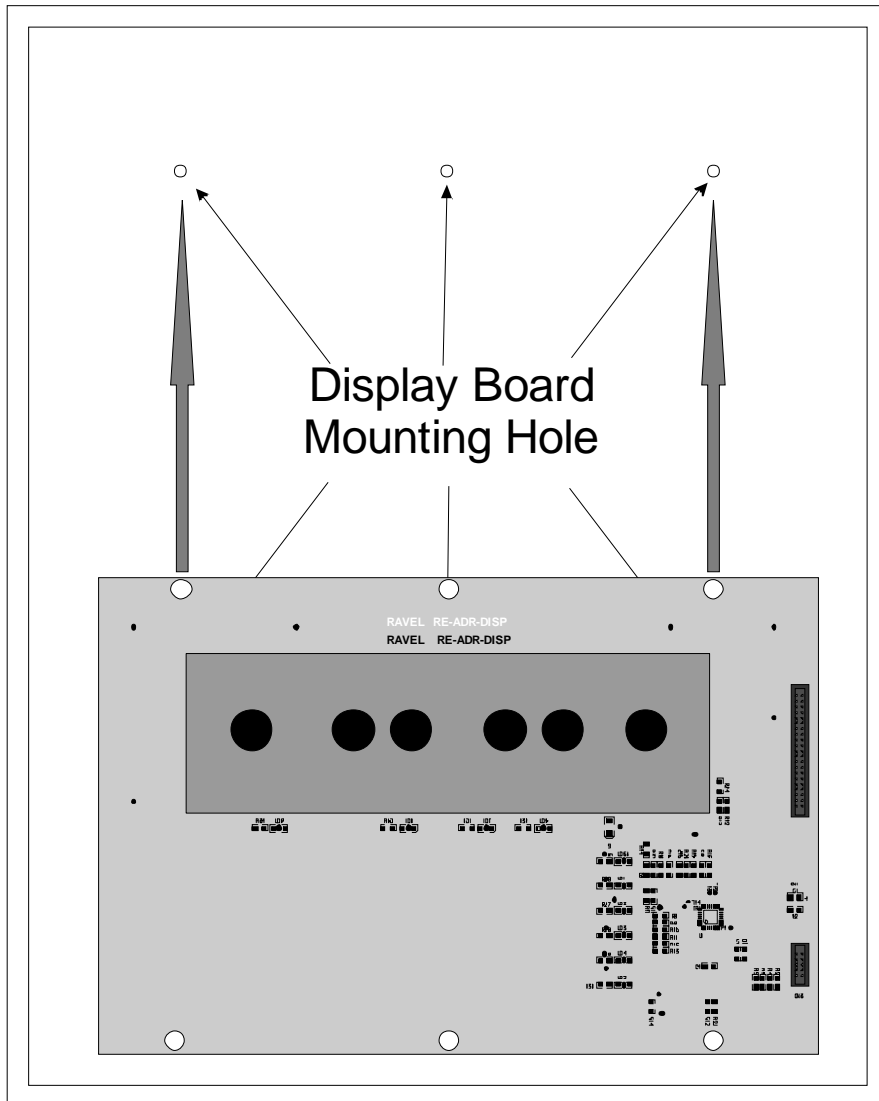

Figure – 19

Mounting position for Power supply unit (RAVEL RE – ADR – PS):

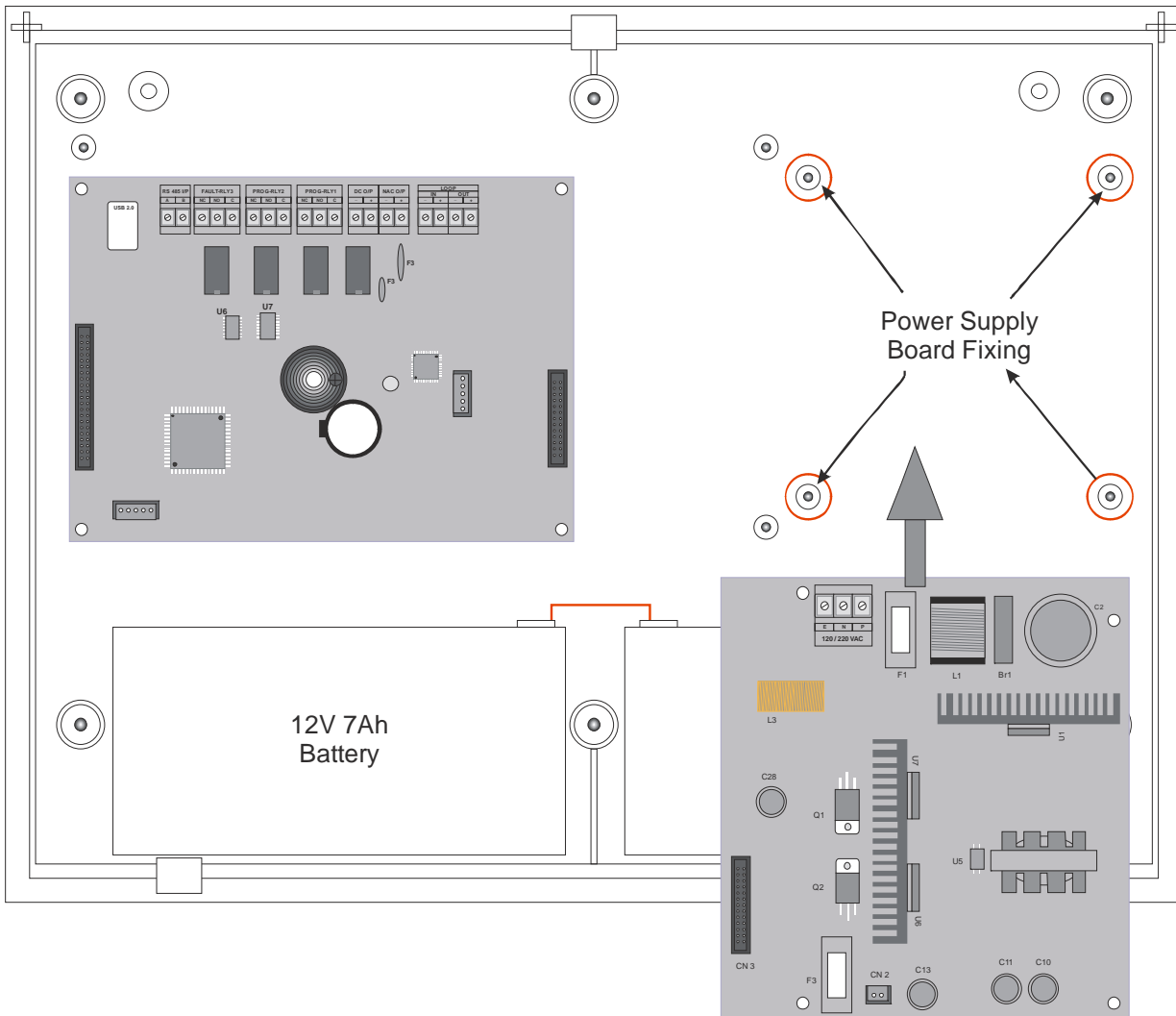

Figure – 20

5.2Lamp Test

The lamp test function done through the sub menu by pressing 'Test' key, system (Panel) is in normal condition. In this mode, all the LED's are checked for good condition by glowing all LED's.

5.3 System Power

Power	Max. AH Capacity	Derating Factor	Max. standby current	Max. Alarm current	Max. standby time	Max. alarm duration
Primary (power supply)	N/A	N/A	0.1A	0.5A	N/A	N/A
Secondary (back up)	7Ah	10%	0.4A	1.8A	24 Hrs.	5 Min.

5.4 Trouble Shooting

Condition	Root Cause	Remedy
There is no indication on The panel	No power to the Panel	Check Primary (AC) power and Standby power.
During Mains fail condition Battery fault LED is glowing	May be battery low (<21.6V) or the battery reaches the de-rated (<19.5V) Voltage.	Check the Battery voltage and charge the battery or replace the battery.
The Battery fault and charger fail shown in LCD.	The Battery connected in reverse.	Connect the battery properly.

Chapter 6: Battery Calculation

Use Table 6-1 to calculate the total standby and alarm load in ampere hours (AH). This total load determines the battery size (in AH), required to support the control panel under the fail of the AC Power Supply. Complete the table 6-1 as follows:

1. Enter the NFPA standby and alarm times (refer to NFPA requirements below).
2. Calculate the ampere-hours for standby and Alarm, and then sum the standby and alarm ampere-hours.
3. Multiply the sum by the derating factor of 1.2 to calculate the proper battery size (in AH).
4. Write the ampere hour requirements on the protected premises label located inside the cabinet door.

Table 6-1: Total Secondary Power Requirements at 24 VDC

 MONITI Battery Calculation											
Secondary Power Source Requirements											
Device Type	Standby Current (amps)					Secondary Alarm Current (amps)					
	Qty		Current Draw	=	Total	Qty		Current Draw	=	Total	
Main Circuit Board	1	x	0.120000	=	0.12000	1	x	0.170000	=	0.17000	
Loop Card	0	x	0.040000	=		0	x	0.085000	=		
DC Output Power											
4-wire Detector Heads	0	x	0.000000	=		0	x	0.000000	=		
Addressable Devices											
RE-337-SH	0	x	0.000500	=							
RE-337-S	0	x	0.000500	=							
RE-337-H	0	x	0.000500	=							
RE-737MC	0	x	0.000500	=							
RE-737MM	0	x	0.000500	=							
RE-737MR	0	x	0.000500	=							
RE-737MZ	0	x	0.000500	=							
RE-737MX	0	x	0.000500	=							
RE-737M	0	x	0.000500	=							
RE-24ES	0	x	0.000500	=							
RE-374BS	0	x	0.000500	=							
RE-716BI	0	x	0.000030	=							
	0	x	0.000000	=							
	0	x	0.000000	=							
					Maximum alarm draw for Addressable devices (SLC)					0.00000	
RE-24ES	0	x	0.000000	=		0	x	0.007000	=		
RE-374BS	0	x	0.000000	=		0	x	0.007000	=		
Miscellaneous Device 3	0	x	0.000000	=		0	x	0.000000	=		
Miscellaneous Device 4	0	x	0.000000	=		0	x	0.000000	=		
Miscellaneous Device 5	0	x	0.000000	=		0	x	0.000000	=		
NAC #1						0	x	0.000000	=		
Current Draw from TB3 (non-alarm)			0.000000	=				0.000000	=		
Sum each column for totals					Total Standby Current	0.12000	Total Alarm Current				0.17000



MONITI Battery Calculation

Note: You can edit all current draws and are **fully responsible for verifying** these calculations. Only enter values in **yellow** cells.

		Required Standby Time in Hours			
		24 Hours			
Standby Load Current (Amps)	0.120 A	x	24	=	2.880 AH
		Required Alarm Time in Hours			
		5 Minutes			
Alarm Load Current (Amps)	0.170 A	x	0.084	=	0.014 AH
Standby and Alarm Load Subtotal				=	2.894 AH
Derating Factor				=	x 1.2
Total Ampere Hours Required				=	3.473 AH

Recommended Batteries:	7AH Batteries
-------------------------------	----------------------

Battery Check	
The batteries can be charged by the MONITI Charger.	
The batteries can be housed in the MONITI Cabinet.	

Current Draw Check	
NAC#1 current is within the limitations of the circuit.	
NAC#2 current is within the limitations of the circuit.	
The standby current is within the limitations of the panel.	
The alarm current is within output limitations of the panel.	

Chapter 7: Wire Requirements

Connecting external system accessories to the MONITI main circuits must be carefully considered to ensure proper operation. It is important to use the correct type of wire, wire gauge and wire run length per each MONITI circuit. Reference the chart below to specify wire requirements and limitations for each MONITI.

TABLE 7-1: Wire Requirements

CIRCUIT TYPE	CIRCUIT FUNCTION	WIRE TYPE AND LIMITATIONS	RECOMMENDED MAX. DISTANCE Feet (meters)	WIRE GAUGE
Initiating Device Circuit	Connects to Initiating Devices	Untwisted, unshielded wire (Do not exceed 100 ohms)	10,000 (3,000 m) 8,000 (2,400 m) 4,875 (1,480 m) 3,225 (975 m)	12 AWG (3.25 mm ²) Belden 9583 WPW999 14 AWG (2.00 mm ²) Belden 9581 WPW995 16 AWG (1.30 mm ²) Belden 9575 WPW991 18 AWG (0.75 mm ²) Belden 9574 WPW975
24 VDC resettable, nonresettable	Connects to annunciators and other accessories	No more than 1.2 volt drop allowed from supply source to end of any branch	Distance limitation set by 1.2 volt maximum line drop	12 AWG (3.25 mm ²) - 18 AWG (0.75 mm ²)

Chapter 8: Compatible Devices

The compatible devices which are connected with this panel are given below:

Total Compatible Addressable Devices: **127 + 20 (LS)** No's Max.

Ravel Detectors:

- RE-337-S : The intelligent Photoelectric Smoke detector.
- RE-337-H : The intelligent Thermal detector.
- RE-337D-SH : The intelligent Multi Photoelectric & Thermal detector.

Ravel Modules:

- RE-737MC : The Control Module.
- RE-737MM : The Monitor Module.
- RE-737MR : The Relay Module
- RE-737MI : The Isolator Module
- RE-737MZ : The Zone Module
- RE-737MX : The Input Output Module
- RE-737M : The Manual Call Point

Compatible NAC's:

1. RE-24CS : Mini Horn
2. RE-24SS : Sounder Cum Strobe
3. RE-24ES : Loop powered Sounder
4. RE-34BS : Loop powered Sounder Base

End Of Line Devices:

1. RE4K7 for External Inputs, Zone, and NACs.

Chapter 9: Abbreviations

NFPA	–	National Fire Protection Association
AC	–	Alternate Current
FACP	–	Fire Alarm control Panel
LCD	–	Liquid Crystal Display
SLC	–	Signaling Line Circuit
Evt	–	Event
NOD	–	Number Of Device
NOM	–	Number Of Modules
DD	–	Date
MM	–	Month
YY	–	Year
LC	–	Loop Card
RTC	–	Real Time Clock
OPTI	–	Optical Detector
MULT	–	Multiple Detector
IP_M	–	Input Module
OP_M	–	Output Module
IO_M	–	Input / Output Module
Cat	–	Category
Del	–	Delete



RAVEL ELECTRONICS PVT LTD

150A, 1st Main Road, Electronic Industrial Estate,
Perungudi, Chennai, Tamil Nadu.

Email : marketing@ravelfire.com; Web : www.ravelfire.com

DATE:

TEST CERTIFICATE

We hereby certify that the items details hereon have been manufactured, inspected and electrically tested to ensure the compliance with ravel products and process specification.

Model No.: MONITI

Serial No.:

No. of Loops:

For **RAVEL ELECTRONICS PVT LTD,**

Q.C. – Engineer

Tested By



RAVEL ELECTRONICS PVT LTD

150A, 1st Main Road, Electronic Industrial Estate,
Perungudi, Chennai, Tamil Nadu..

Email : marketing@ravelfire.com; Web : www.ravelfire.com

WARRANTY CERTIFICATE

Model No.: MONITI

Serial No.:

Ravel Electronics warrants each product to be free from defects in material and workmanship. This obligation is limited to servicing or part returned to the company for that purpose and making good any parts thereof which shall be within warranty period, returned to the company under a written intimation and which to the company's satisfaction to be found defective. The company reserves the right to decide the workplace for the repair work. The freight for defective material will have to be borne by the purchaser, and the transit risk for such material will rest with the purchaser.

This warranty will last for a period of **12 months** from the date of Invoice of the product from the factory. The warranty is applicable only if the product is used within its specifications. The warranty for the replaced components will lapse along with that of the main product.

THIS WARRANTY IS VALID UP TO: 12 months from the date of invoice

Authorised Signatory

Ravel Electronics Pvt Ltd.,

150A, 1st Main Road,
Electronic Industrial Estate,
Perungudi, Chennai, Tamil Nadu.

Web: www.ravelfire.com

Email: marketing@ravelfire.com